



**Datrend  
Systems Inc.**

# Infutest 2000

## *Series E*

*Dual Channel Infusion Pump Analyzer*

Operating Manual



Infutest 2000 Series E  
*Dual Channel Infusion Pump Analyzer*  
Operating Manual

---

© 2005 Datrend Systems Inc.  
Unit #1 - 3531 Jacombs Road  
Richmond, BC • CANADA • V6V 1Z8  
Tel 604.291.7747 or 800.667.6557 • Fax 604.294.2355  
e-mail [customerservice@datrend.com](mailto:customerservice@datrend.com)





Revision	Revision History Description	Date
A	Initial Release	31-Aug-2005

---

**Copyright**

Datrend Systems Inc. ("DSI") agrees to a limited copyright release that allows you to reproduce manuals and other printed materials for use in service training programs and other technical publications. If you would like other reproductions or distributions, submit a written request to Datrend Systems Inc.

---

**Unpacking and Inspection**

Follow standard receiving practices upon receipt of the instrument. Check the shipping carton for damage. If damage is found, stop unpacking the instrument. Notify the freight carrier and ask for an agent to be present while the instrument is unpacked. There are no special unpacking instructions, but be careful not to damage the instrument when unpacking it. Inspect the instrument for physical damage such as bent or broken parts, dents, or scratches.

---

**Claims**

Our routine method of shipment is via common carrier. Upon delivery, if physical damage is found, retain all packing materials in their original condition and contact the carrier immediately to file a claim. If the instrument is delivered in good physical condition but does not operate within specifications, or if there are any other problems not caused by shipping damage, please contact your local sales representative or DSI immediately.

---

**Standard Terms and Conditions****Refunds & Credits**

Please note only serialized products (products labelled with a distinct serial number) and accessories are eligible for partial refund and/or credit. Non-serialized parts and accessory items (cables, carrying cases, auxiliary modules, etc.) are not eligible for return or refund. In order to receive a partial refund/credit, the product must not have been damaged, and must be returned complete (meaning all manuals, cables, accessories, etc.) within 90 days of original purchase and in "as new" and resalable condition. The *Return Procedure* must be followed.

**Return Procedure**

Every product returned for refund/credit must be accompanied by a Return Material Authorization (RMA) number, obtained from Datrend Customer Service. All items being returned must be sent prepaid (freight, duty, brokerage, and taxes ) to our factory location.

**Restocking Charges**

Products returned within 30 days of original purchase are subject to a minimum restocking fee of 15%. Products returned in excess of 30 days after purchase, but prior to 90 days, are subject to a minimum restocking fee of 20%. Additional charges for damage and/or missing parts and accessories will be applied to all returns. Products which are not in "as new" and resalable condition, are not eligible for credit return and will be returned to the customer at their expense.

---

**Certification**

This instrument was thoroughly tested and inspected and found to meet DSI's manufacturing specifications when it was shipped from the factory. Calibration measurements are traceable to the National Research Council of Canada (NRC) and/or the National Institute of Standards and Technology (NIST). Devices for which there are no NRC/NIST calibration standards are measured against in-house performance standards using accepted test procedures.

---

## Warranty

### Warranty and Product Support

Datrend Systems Inc. ("DSI") warrants this instrument to be free from defects in materials and workmanship under normal use and service for two (2) years from the date of original purchase, providing the instrument is calibrated in accordance with Appendix C of this manual. During the warranty period DSI will, at our option, either repair or replace a product at no charge that proves to be defective; provided you return the product (shipping, duty, brokerage and taxes prepaid) to DSI. Any and all transportation charges incurred are the responsibility of the purchaser and are not included within this warranty. This warranty extends only to the original purchaser and does not cover damage from abuse, neglect, accident or misuse or as the result of service or modification by other than DSI. **IN NO EVENT SHALL DATREND SYSTEMS INC. BE LIABLE FOR CONSEQUENTIAL DAMAGES.**

No warranty shall apply when damage is caused by any of the following:

- Introduction of fluids not specified in the instruction manual,
- Application of excessive pressure or vacuum/suction to the device inputs,
- Failure to rinse or clear the fluid flow path as instructed in the manual,
- Power failure, surges, or spikes,
- Damage in transit or when moving the instrument,
- Improper power supply such as low voltage, incorrect voltage, defective wiring or inadequate fuses,
- Accident, alteration, abuse or misuse of the instrument,
- Fire, water damage, theft, war, riot, hostility, acts of God, such as hurricanes, floods, etc.

Only serialized products (those items bearing a distinct serial number tag) and their accessory items are covered under this warranty. **PHYSICAL DAMAGE CAUSED BY MISUSE OR PHYSICAL ABUSE IS NOT COVERED UNDER THE WARRANTY.** Items such as cables and non-serialized modules are not covered under this warranty.

This warranty gives you specific legal rights and you may have other rights, which vary from province to province, state to state, or country to country. This warranty is limited to repairing the instrument to DSI's specifications.

When you return an instrument to DSI for service, repair or calibration, we recommend shipment using the original shipping foam and container. If the original packing materials are not available, we recommend the following guide for repackaging:

- Use a double-walled carton of sufficient strength for the weight being shipped.
- Use heavy paper or cardboard to protect all instrument surfaces. Use nonabrasive material around all projecting parts.
- Use at least four inches of tightly packed, industrial-approved, shock-absorbent material all around the instrument.

DSI will not be responsible for lost shipments or instruments received in damaged condition due to improper packaging or handling. All warranty claim shipments must be made on a prepaid basis (freight, duty, brokerage, and taxes). No returns will be accepted without a Return Materials Authorization ("RMA") number. Please contact Datrend at 1-800-667-6557 to obtain an RMA number and receive help with shipping/customs documentation.

Recalibration of instruments, which have a recommended annual calibration frequency, is not covered under the warranty.

---

### Warranty Disclaimer

Should you elect to have your instrument serviced and/or calibrated by someone other than Datrend Systems, please be advised that the original warranty covering your product becomes void when the tamper-resistant Quality Seal is removed or broken without proper factory authorization. We strongly recommend, therefore, that you send your instrument to Datrend Systems for service and calibration, especially during the original warranty period. In all cases, breaking the tamper-resistant Quality Seal should be avoided at all cost, as this seal is the key to your original instrument warranty. In the event that the seal must be broken to gain internal access to the instrument (e.g., in the case of a customer-installed firmware upgrade), you must first contact Datrend Systems at 1-800-667-6557. You will be required to provide us with the serial number for your instrument as well as a valid reason for breaking the Quality Seal. You should break this seal only after you have received factory authorization. Do not break the Quality Seal before you have contacted us! Following these steps will help ensure that you will retain the original warranty on

your instrument without interruption.

---

**WARNING**

Unauthorized user modifications or application beyond the published specifications may result in electrical shock hazards or improper operation. Datrend Systems will not be responsible for any injuries sustained due to unauthorized equipment modifications.

**DSI DISCLAIMS ALL OTHER WARRANTIES, EXPRESSED OR IMPLIED, INCLUDING ANY WARRANTY OF MERCHANTABILITY OR FITNESS FOR A PARTICULAR PURPOSE OR APPLICATION.**

<p><b>THIS PRODUCT CONTAINS NO USER-SERVICEABLE COMPONENTS. UNAUTHORIZED REMOVAL OF THE INSTRUMENT COVER SHALL VOID THIS AND ALL OTHER EXPRESSED OR IMPLIED WARRANTIES.</b></p>
---

Fluke® is a registered trademark of Fluke Corporation

MS-DOS, QBasic, Visual Basic, and Visual C++, Microsoft, and Windows are registered trademarks of Microsoft Corp.

Brita® is a registered trademark of BRITA Worldwide.

Jet Dry® is a registered trademark of Reckitt Benckiser plc





---

## Table of Contents

---

1. PERFORMANCE SPECIFICATIONS .....	1
1.1 Single Rate Test .....	1
1.1.1 Continuous Flow Conditions .....	1
1.1.2 Pulsatile Flow Conditions .....	2
1.2 Dual Rate Test .....	3
1.2.1 Continuous Flow Conditions <u>ONLY</u> .....	3
1.3 PCA Pump Test .....	4
1.3.1 Continuous Flow Conditions <u>ONLY</u> .....	4
1.4 Occlusion Pressure Test .....	5
1.4.1 Pressure Measurement .....	5
1.4.2 Nurse Call Detection .....	5
1.5 Data Logger .....	5
1.6 Interface .....	6
1.7 Accessories .....	8
2. OVERVIEW OF INSTRUMENT .....	9
2.1 General Description .....	9
2.2 Description of Test Procedures .....	13
2.2.1 Single Rate Test .....	13
2.2.2 Dual Rate Test .....	14
2.2.3 PCA Pump Test .....	14
2.2.4 Occlusion Pressure Test .....	14
2.3 Test Fluids .....	15
3. INITIAL SET-UP .....	17
3.1 Connections .....	17
3.2 Priming .....	18
3.3 Optional Connections .....	22
4. OPERATION AND RELATED DISPLAYS .....	25
4.1 Powering Up and Setting the Clock .....	25
4.2 Setting Up a Test .....	29
4.3 Test Measurement Concepts .....	30
4.3.1 SynchroStart .....	30
4.3.2 End-of-Infusion Analysis .....	30
4.3.3 Flow Pattern Classification .....	30
4.4 Starting a Test .....	31
4.5 Running a Test .....	31
4.6 Viewing the Test Summary .....	34
4.6.1 SUMMARY Screen for Single-Rate Test .....	34
4.6.2 SUMMARY Screen for Dual-Rate Test .....	35
4.6.3 SUMMARY Screen for PCA Pump Test .....	35

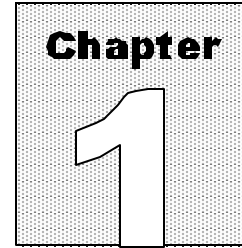
## INFUTEST 2000E OPERATING MANUAL

4.6.4	SUMMARY Screen for Occlusion Pressure Test	36
4.6.5	SUMMARY Screen Usage	37
4.7	Viewing the Data Log	38
4.7.1	Data Log Description	38
4.7.2	DATA Screen Usage	38
4.8	Output of Summary and Data Logs	41
4.9	Alarms	45
4.9.1	Nonrecoverable Alarms	45
4.9.2	Recoverable Alarms	45
4.10	AutoSequences	47
5.	TEST USAGE GUIDELINES	51
5.1	General Rules	51
5.1.1	Test Fluids	51
5.1.2	Pump IV Sets and Syringes	53
5.1.3	Cleaning	54
5.1.4	Input and Output Connections	55
5.1.5	Flushing Prior to Test Startup	56
5.2	Single Rate Test	58
5.2.1	Test Description	58
5.2.2	Test Usage	60
5.3	Dual-Rate Test	62
5.3.1	Testing Piggyback Operation	62
5.3.2	Testing Titrated Rates	63
5.3.3	Testing KVO Operation	64
5.3.4	Testing Bolus-Plus-Basal Mode Operation	64
5.3.5	Dual-Rate "PULSATILE" Warning	65
5.4	PCA Pump Test	66
5.4.1	Test Description	66
5.4.2	Test Usage	67
5.4.3	PCA Pump "PULSATILE" Warning	68
5.5	Occlusion Pressure Test	69
5.5.1	Measuring Occlusion Pressure	69
5.5.2	Checking the Nurse Call Alarm	69
5.6	AutoSequences	71
5.6.1	Running Default Test Sequences	71
5.6.2	Reloading Default Test Sequences	73
5.6.3	Adding the Occlusion Test to Sequences	73
5.7	Understanding Your Test Results	75
6.	REMOTE CONTROL	79
6.1	Overview	79
6.2	Connections	80
6.3	Command Syntax	80
6.4	Command Types and Return Values	81
6.5	Command List	82

## **INFUTEST 2000E OPERATING MANUAL**

6.6 Command Descriptions .....	83
6.6.1 Test Control Commands - RUN TEST .....	83
6.6.2 Test Control Commands - RUN AUTOSEQUENCE .....	84
6.6.3 Test Control Commands - STOP TEST/ABORT AUTOSEQUENCE .....	84
6.6.4 Report Output Control - PRINT REPORT .....	85
6.6.5 Report Output Control - DOWNLOAD REPORT .....	85
6.6.6 Get Data Commands - GET TEST SUMMARY .....	86
6.6.7 Get Data Commands - GET REAL-TIME DATA .....	87
6.7 Programming Examples .....	90
6.7.1 QBasic Programming .....	90
6.7.2 medTester Programming .....	98
 APPENDIX A. BACK PRESSURE TESTING .....	 99
 APPENDIX B. OPERATIONAL OVERVIEW .....	 103
B.1 General Description .....	103
B.2 Flow Measurement System .....	104
B.3 Pressure Measurement System .....	106
 APPENDIX C. CALIBRATION .....	 107
C.1 Annual Calibration .....	107
C.2 Calibration Verification .....	107
C.2.1 Pressure Accuracy Verification - Field Test .....	107
C.2.2 Flow Accuracy Verification - Field Test .....	107

**INFUTEST 2000E OPERATING MANUAL**



# Introduction

*This chapter provides the performance specifications of the Infutest 2000E (Infutest) Infusion Device Analyzer.*

## 1. PERFORMANCE SPECIFICATIONS

The following specifications apply to both channels of the Infutest 2000 Series E Dual Channel Infusion Device Analyzer.

### 1.1 Single Rate Test

#### 1.1.1 Continuous Flow Conditions

##### I. Flow Measurement

- |  |  |
|--|--|
| a. Nominal range:                                | 0.1 - 999 ml/hr                                    |
| b. Maximum flow measurable and displayed:        | 1700 ml/hr   |
| c. Minimum flow measurable and displayed:        | 0.04 ml/hr   |
| d. Maximum display resolution:                   | 0.001 ml/hr  |
| e. Measuring time:                               | 10 min. at 0.1 ml/hr<br>20 sec. max. above 6 ml/hr |
| f. Accuracy                                      |  |
| Average flow:                                    | +/- 1%, 0.1-999ml/hr                               |
| g. Ranges:                                       | LOW - 0.1 to 170 ml/h<br>HIGH - 170 to 999 ml/h    |
| h. Range selection:                              | Automatic  |
| i. Internal nominal effective collection volume: | LOW range: 0.014 ml<br>HIGH range: 1.1 ml          |

## INFUTEST 2000E OPERATING MANUAL

### II. Volume Measurement

- a. Range: 0 - 9999 ml
- b. Maximum display resolution: 0.001 ml
- c. Accuracy: +/- 1%

### III. Back Pressure Measurement

- a. Range: 0 - 300 mmHg
- b. Zero offset error: +/- 5 mmHg
- c. Display resolution: 1 mmHg
- d. Accuracy: +/- 1% FS,  
+/- zero offset error

### IV. Elapsed Time Measurement

- a. Range: 0 - 100 hours
- b. Display format: hh:mm:ss
- c. Accuracy: +0, -1second

## 1.1.2 Pulsatile Flow Conditions

### I. Flow Measurement

- a. Nominal range: 5 - 999 ml/hr
- b. Maximum flow measurable and displayed: 1700 ml/hr
- c. Minimum flow measurable and displayed: 2.75 ml/hr
- d. Maximum display resolution: 0.001 ml/hr
- e. Measuring time: 14 min. at 5 ml/hr  
20 sec. max. above 200 ml/hr
- f. Accuracy:  
Average flow +/- 1%
- g. Ranges: HIGH range only  
(internally selected)
- h. Internal nominal effective  
collection volume: 1.1 ml

### II. Volume Measurement

- a. Range: 0 - 9999 ml
- b. Maximum display resolution: 0.001 ml
- c. Accuracy: +/- 1%

**III. Back Pressure Measurement**

- Same as for Continuous Flow Measurement

**IV. Elapsed Time Measurement**

-Same as for Continuous Flow Measurement

**1.2 Dual Rate Test**

**1.2.1 Continuous Flow Conditions ONLY**

**I. Flow Measurement**

- a. Nominal range: 0.1 - 170 ml/hr
- b. Maximum flow measurable and displayed: 200 ml/hr
- c. Minimum flow measurable and displayed: 0.04 ml/hr
- d. Maximum display resolution: 0.001 ml/hr
- e. Measuring time: 10 min. at 0.1 ml/hr  
20 sec. max. above 6 ml/hr
- f. Accuracy:
  - Average flow: +/- 1%
- g. Ranges: LOW range only
- h. Delivery period determination: Automatic
- i. Internal nominal effective collection volume: 0.014 ml

**II. Volume Measurement**

- See 1.1 SINGLE RATE TEST, Continuous Flow Measurement

**III. Back Pressure**

- See 1.1 SINGLE RATE TEST, Continuous Flow Measurement

**IV. Elapsed Time Measurement**

- See 1.1 SINGLE RATE TEST, Continuous Flow Measurement



## 1.3 PCA Pump Test

### 1.3.1 Continuous Flow Conditions ONLY

- I. Flow Measurement, Bolus Delivery period**
- |  |  |
|--|--|
| a. Nominal range:                                | 0.1 - 170 ml/hr                                    |
| b. Maximum flow measurable and displayed:        | 200 ml/hr  |
| c. Minimum flow measurable and displayed:        | 0.04 ml/hr   |
| d. Maximum display resolution:                   | 0.001 ml/hr  |
| e. Measuring time:                               | 10 min. at 0.1 ml/hr<br>20 sec. max. above 6 ml/hr |
| f. Accuracy:                                     |  |
| Average flow:                                    | +/- 1%   |
| g. Ranges:                                       | LOW range only                                     |
| h. Lockout detection:                            | Automatic  |
| i. Internal nominal effective collection volume: | 0.014 ml   |
- II. Volume Measurement**
- See 1.1 SINGLE RATE TEST, Continuous Flow Measurement
- III. Back Pressure Measurement**
- See 1.1 SINGLE RATE TEST, Continuous Flow Measurement
- IV. Elapsed Time Measurement**
- See 1.1 SINGLE RATE TEST, Continuous Flow Measurement
- V. Lockout Time Measurement**
- |                    |                 |
|--------------------|-----------------|
| a. Range:          | 0 - 100 minutes |
| b. Display format: | mm:ss           |
| c. Accuracy:       | +/- 2 seconds   |

## 1.4 Occlusion Pressure Test

### 1.4.1 Pressure Measurement

- |                        |                              |
|------------------------|------------------------------|
| a. Display Units:      | mmHg, psi                    |
| b. Range:              | 0 - 2586 mmHg(0 - 50 psi)    |
| c. Display resolution: | 1 mmHg(0.1 psi)              |
| d. Measuring time:     | 2 seconds                    |
| e. Zero offset error:  | +/- 5 mmHg (0.1 psi)         |
| f. Accuracy:           | +/- 1% +/- zero offset error |

### 1.4.2 Nurse Call Detection

- Nurse Call signal from pump sampled once per second.
- Nurse Call signal can be produced by any of: relay contacts, open collector output, TTL output, RS-232 level, or 20 mA current loop.
- Nurse Call signal may be in either logical state at start of Occlusion Pressure Test.

## 1.5 Data Logger

- Memory Type:**  
NVRAM (battery-backed)
- Capacity:**

2 channel	900 flow measurements per channel 700 pressure measurements per channel
4 channel	450 flow measurements per channel 350 pressure measurements per channel
- Data Output:**  
Directable to printer or serial port following completion of a test or AutoSequence.

## **1.6 Interface**

### **I. User Interface:**

40-character by 8-line backlit LCD  
4 front panel soft-keys  
Internal beeper  
LCD contrast control (rear panel)

### **II. Fluid interface:**

Inputs A and B: Delrin twistlock, self-sealing  
Common output A&B: Delrin twistlock

### **III. PCA Pump Trigger Outputs:**

Mechanical - One 1/4" female stereo phono  
jack per channel  
Electrical - Relay contacts rated at 120 VAC, 1 A;  
normally open and normally  
closed contacts available.

### **IV. Nurse Call Inputs:**

Mechanical - One 1/4" female stereo phono  
jack per channel  
Electrical - 50K-ohm differential input impedance.

### **V. Parallel Port:**

Centronix standard printer interface,  
DB-25 female connector

### **VI. Printer Driver:**

Epson MX/FX Series, 80 cps  
80 columns and 66 lines per page

### **VII. Serial Port:**

Mechanical - DB-25 male connector  
Electrical - RS-232C; bidirectional; CTS handshaking;  
9600 baud, 8 data bits, no parity bit, 1 stop bit

### **VIII. Power Supply:**

120 VAC 60 Hz @ 12 W  
(230/240 VAC 50 Hz Europe/UK)

## INFUTEST 2000E OPERATING MANUAL

### IX. Fuse:

AGC 500mA, 250V @ 120 VAC Input  
AGC 300mA, 250V @ 220-240 VAC Input

### X. Environment:

15°C to 40°C  
10% to 90% RH  
Indoor Use Only  
Category II  
Pollution Degree 2

### XI. Dimensions:

12" W x 12" D x 6" H  
30.5 cm W x 30.5 cm D x 15.2 cm H

### XII. Weight:

10 lbs.  
4.5 kg

## **1.7 Accessories**

### **I. Standard Accessories:**

AC line cord

I/O tubing set, comprising two IEC<sup>1</sup> recommended 21 gauge flow restrictors, two three-way stop cocks and two Luer-lock to Delrin twistlock extension sets, P/N 7300-005

Flushing syringe (60cc)

### **II. Optional Accessories:**

6' RS-232 Serial Port cable, DB25 - DB25 (SSC -1), P/N 7100-062

6' RS-232 Serial Port cable, DB25 - DB9 (SSC -2), P/N 7100-065

6' PCA Pump trigger cable, unterminated (PCA -1), P/N 7100-061

6' Nurse Call Alarm cable, unterminated (NCA -1), P/N 7100-060

6' Parallel Printer Cable (PPC-1), P/N 7100-064

Remote Sensor Module (RSM):

- North America, 120 VAC/60 Hz, P/N: 8000-021

- Europe, 220 VAC/50 Hz, P/N:8000-023

- United Kingdom, 240 VAC/50Hz, P/N: 8000-022

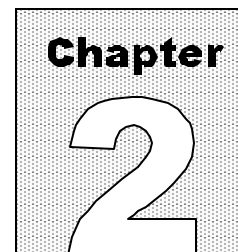
RSM Connector Cable (AUX-1), P/N 7100-279

### **III. Software Accessories:**

Data Transfer and Graphing Program (DTP) for Windows

---

<sup>1</sup>IEC 601-2-24, Part 2, Particular requirements for safety of infusion pumps and controllers



## Overview

*This chapter gives an overview of the capabilities of the Infutest, the tests performed and test fluid recommendations.*

## 2. OVERVIEW OF INSTRUMENT

### 2.1 General Description

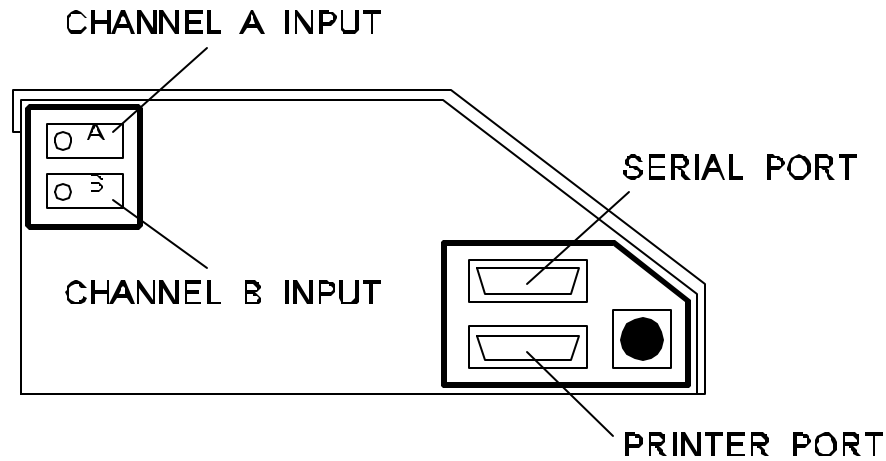
The Infutest is an automated, self-contained system for performing flow rate, effused volume, and occlusion pressure tests on medical infusion devices. In addition to the Single Rate test, Infutest is also capable of automatically checking Patient-Controlled Analgesia (PCA) pumps for correct lockout operation, and for testing pumps capable of delivering dual rates - two preset volumes at differing flow rates (i.e. primary/secondary delivery or delivery "piggybacking").

The Infutest has two independently-functioning channels, designated **A** and **B**, for simultaneously performing any of four basic, selectable test procedures on up to two infusion devices. Tests performed simultaneously may be different for each infusion device being evaluated. For example, a Single Rate Test may be performed on a syringe pump connected to Channel A while a PCA pump is undergoing a lockout time measurement on Channel B. In addition to the manual selection of the four basic tests (Single Rate, Dual-Rate, PCA and Occlusion Pressure), Infutest has the ability to create pump test protocols, termed **AutoSequences**. The nine (9) test sequences are user configurable to automate testing and data collection based on manufacturer or user test protocols. **AutoSequences** may greatly improve on productivity by standardizing on test protocols, and minimizing user setup time.

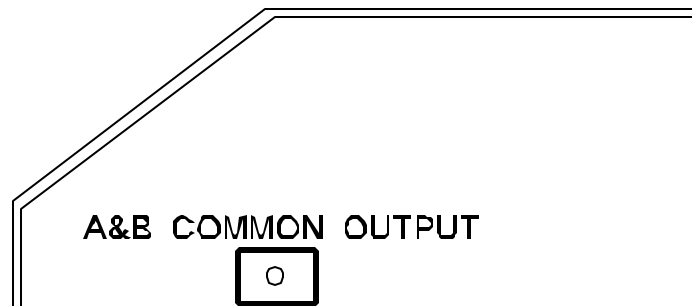
In addition to the two channel Infutest, a Remote Sensor Module (RSM) may be added to expand the Infutest to a four channel system. Throughout the manual, wherever reference is made to the capabilities of **Channel A** or **B**, or switching from **Channel A** to **B**, this may be extended to include channels **C** and **D** if an RSM is connected. All actions of the RSM are controlled by the Infutest base unit and all results are presented on the Infutest LCD display.

## INFUTEST 2000E OPERATING MANUAL

On its front panel, the Infutest provides a menu-driven user interface which is implemented with a liquid crystal display (LCD) and four multi-function, software-defined push buttons ("soft keys"). The left panel of the Infutest (*Figure 1*) provides both a Centronix-standard parallel port (DB25 female) for connection to an Epson FX Series or compatible printer, and a RS-232 serial port (DB25 male) for data output to a personal computer or other data collection instrument. Also located on the left panel are two Delrin twistlock, self-sealing connectors which serve as a fluid inputs for Channels A and B. Fluid exits the Infutest via a Delrin twistlock connector which provides the Channel A & B common output (*Figure 2*). Inputs for pump Nurse Call signals and outputs for triggering PCA pumps are provided on the Infutest rear panel (*Figure 3*).

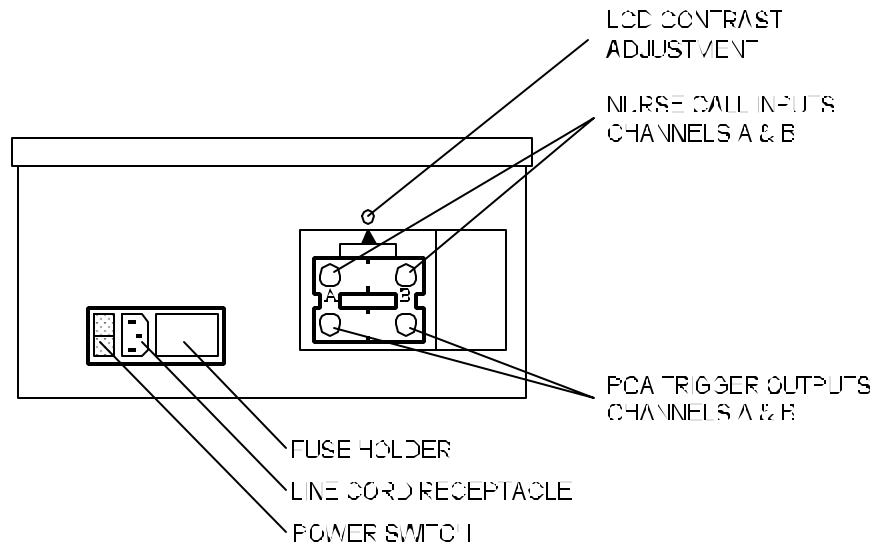


*Figure 1 - Infutest left panel*



*Figure 2 - Infutest right panel*

## INFUTEST 2000E OPERATING MANUAL



*Figure 3 - Infutest rear panel*

The Infutest incorporates a time/date clock and a data logger capable of storing up to 900 flow measurements and 700 occlusion pressure measurements per channel. A "flow measurement" comprises elapsed time (in hours, minutes and seconds), flow rate, average flow, total effused volume and back pressure for the Single Rate, Dual-Rate and PCA Pump Tests. A "pressure measurement" comprises elapsed time, occlusion pressure and Nurse Call Alarm status for the Occlusion Pressure Test.

When an RSM is connected to the Infutest, the data log is initialized to 450 flow and 350 pressure measurements for each of the four channels.

The Infutest also provides a Summary for each channel. A Summary condenses the raw data obtained from a test into a few important values, such as the average flow measured during the test, and the total volume of fluid that was effused. An Occlusion Pressure Summary is also included to provide a synopsis of Occlusion Pressure Test results.

Upon completion of a test, contents of the channel Data Log, the channel Summary, or both may be output to a printer or downloaded to a personal computer via the serial port. Multiple copies of the test results may be output in succession, and each copy may be directed to either the printer or the serial port at the user's option.



## INFUTEST 2000E OPERATING MANUAL

To accommodate long-term testing or special testing needs, the Infutest may be controlled remotely via RS-232C using the Infutest Remote Control (IRC) command set (see Section 6). This command set allows the Infutest to be setup and controlled by a user designed program. Data may be collected in real-time, allowing long-term testing and data collection.

The Infutest incorporates a non-volatile memory which allows the instrument to be disconnected from the line and transported without losing previously acquired test results. At power-up, the user may select to view or output the contents of a channel's Data Log or Summary, which are both retained in the non-volatile memory. Initial test settings are also preserved when the AC supply is disconnected.

A Windows based software accessory, available from Datrend Systems (the Infutest Data Transfer Program - **DTP**), facilitates transfer of test results from the Infutest to a personal computer, and conversion of Infutest Data Log and Test Summary Report files to numeric data files suitable for importing into most spreadsheet or database programs. DTP also has the ability to graphically display and print flow versus time graphs and trumpet (error bounds) graphs.

## **2.2 Description of Test Procedures**

Each channel of the Infutest is capable of making the following measurements:

- i **Flow Rate** ranging from 0.1 up to 999 milliliters per hour;
- ii **Effused Volume** up to 9999 milliliters;
- iii **Pulsatile Flow** ranging from 5 up to 999 milliliters per hour;
- iv **Keep-Vein-Open (KVO) Rate** following primary delivery;
- v **PCA pump Delivery Rate** during bolus infusion, ranging from 0.1 up to 170 milliliters per hour;
- vi **Bolus Volume** delivered by PCA pump;
- vii **Number of Boluses** delivered from PCA pump, up to 255;
- viii **Lockout Time** between PCA pump bolus deliveries, in minutes and seconds;
- ix **PCA pump Basal Rate** following bolus delivery (using Dual-Rate Test);
- x **Back Pressure** applied to infusion device, up to 300 mmHg;
- xi **Occlusion Pressure** produced by infusion device, up to 2586 mmHg (50 psi); and
- xii **Status of Nurse Call Alarm** from infusion device (ON or OFF).

The above measurements are organized into four **basic test protocols**. These test protocols are:

### **2.2.1 Single Rate Test**

Use the Single Rate Test to evaluate the basic performance of **all medical infusion devices**. The Single Rate Test measures **Flow Rate** (instantaneous and average), **Effused Volume**, and **Back Pressure**.

In addition to accommodating **continuous flow** infusion devices, the Single Rate test also incorporates automated detection and averaging of **pulsatile flow** for increased measurement accuracy of **bolus-discharge** and other non-continuous pumping devices.

### **2.2.2 Dual Rate Test**

Use the Dual-Rate Test to evaluate infusion devices capable of primary/secondary delivery or delivery "piggybacking", that is, delivery of a first preset volume at a first rate followed by delivery of a second preset volume at a second rate. The Dual-Rate Test measures **Flow Rate** (instantaneous and average), **Effused Volume**, and **Back Pressure** for each delivery programmed into the Dual-Rate pump.

Also use the Dual-Rate Test to evaluate **Keep-Vein-Open (KVO)** operation and **PCA Bolus-Plus-Basal mode** delivery with infusion devices which incorporate these features.

### **2.2.3 PCA Pump Test**

Use the PCA Pump Test to evaluate the basic performance of Patient-Controlled infusion devices. The PCA Pump Test measures **Flow Rate** (instantaneous and average) and **Bolus Volume** for each bolus delivery, the **Lockout Time** between bolus deliveries, and the **Number of Boluses** delivered during the test. **Back Pressure** is also measured.

### **2.2.4 Occlusion Pressure Test**

Use the Occlusion Pressure Test to measure the **maximum pressure** generated by an infusion device when its output is occluded. Also use the Occlusion Pressure Test to check the operation of the **Nurse Call Alarm** on pumps which incorporate this feature.

## **2.3 Test Fluids**

The following test fluids are acceptable for use with the Infutest:

- 1. DISTILLED WATER**
- 2. CLEAN DOMESTIC WATER (i.e. "tap water")**

Common distilled water is the preferred test fluid. If domestic water is employed, occasional flushing with distilled water may be required following use, depending on hardness and quality of the local water. The test fluid should be colourless and should not contain visible particulate matter. An agent for reducing surface tension of the test fluid is normally not required for routine use. However a wetting agent, such as Jet Dry, may be added if required. In the case of Jet Dry, a concentration of 1.0 ml per litre of test fluid is recommended as a starting point. Wetting agent concentration may have to be varied depending the purity of the test fluid.

### **IMPORTANT:**

**THE USE OF SALINE SOLUTION AS A TEST FLUID IS STRONGLY DISCOURAGED, AND WILL VOID THE WARRANTY. IN THE EVENT SALINE SOLUTION IS ACCIDENTALLY USED, THE INFUTEST SHOULD BE FLUSHED WITH DISTILLED WATER.**

**DO NOT USE DEXTROSE IN WATER (eg. D5W, D25W) OR OTHER VISCOUS TEST FLUIDS WITH THE INFUTEST. USE OF SUCH FLUIDS WILL VOID THE WARRANTY.**

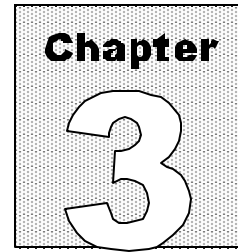
If the instrument is in daily use, **both channels should be kept primed between tests** provided that distilled water or low hardness domestic water is employed. **If the instrument is to be stored for several months or transported**, fluid should be drained from the unit by forcing air into each channel input with a large syringe while the alternate input is blocked. The instrument should then be carefully blown out from the A and B inputs to the common output using **clean**, dry compressed air.

For the remainder of this manual, the test fluid is assumed to be distilled water or low-hardness domestic water, and is referred to generically as "water".

**IMPORTANT:**

IV sets which ***have*** or ***may have*** come in contact with saline or dextrose or other IV fluids ***should not be used*** on the Infutest. If an administration set ***must*** be re-used (i.e. as part of an incident investigation), ensure the set has been flushed out thoroughly with clean water before connecting the set to the Infutest. Most IV fluids contain salts and sugars which can degrade and **potentially ruin** the high-precision flow sensors inside the Infutest.

It is always best to use a new administration set when testing a pump. However, the same administration set may be re-used to test several pumps provided the set is primed **only with distilled or “sterile” water**. Change IV set per the manufacturer’s recommendations to ensure that test results reflect clinical use of the infusion device.



## Set-up

*This chapter describes the initial set-up of the Infutest, describes the basic fluid connections, fluid priming, and serial and parallel output connections.*

### 3. INITIAL SET-UP

#### 3.1 Connections

- a. Place the instrument on a stable, horizontally level surface. Connect electrical power to the unit by inserting the power cable into the rear panel receptacle (*Figure 3*) and connecting the cable to a grounded outlet.
- b. Connect the input tubing set (consisting of the IEC recommended 21 gauge flow restrictor, three-way stop cock, and extension set) to the Channel A fluid input (*Figure 1, Figure 4*). Similarly, connect the second input tubing set to Channel B. This arrangement is recommended for proper instrument operation.
- c. Connect the output extension set to the Channel A & B common output (*Figure 2, Figure 7*). The A & B Output should drain into a collection vessel of appropriate volume ideally located on the bench near the Infutest. A small (250 to 500 ml) beaker will suffice for most test situations.

**The collection vessel should not be located more than 36" below the level of the A & B Output. This will prevent a vacuum from being applied to the Infutest which could damage the internal pressure sensors, or cause a pressure zero error when the Infutest is powered up.**

*Refer to the instructions in Appendix A if a Back Pressure is to be applied to the Infutest to oppose the flow from the infusion device.*

### 3.2 Priming

Figure 4, Figure 5 and Figure 6 on the following page show the three possible positions of the stop cock connected to a channel input. As illustrated, the three positions are referred to as ON, PRIME or FLUSH, and OFF.

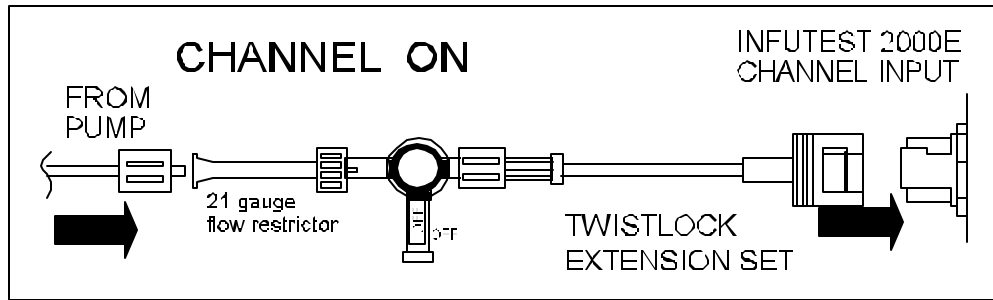


Figure 4 - Connection of stop cock to channel input, channel ON.

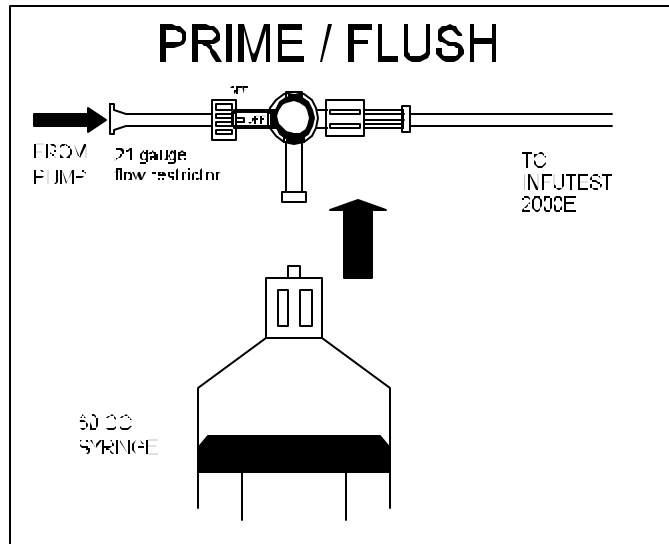


Figure 5 - Stop cock position for priming / flushing

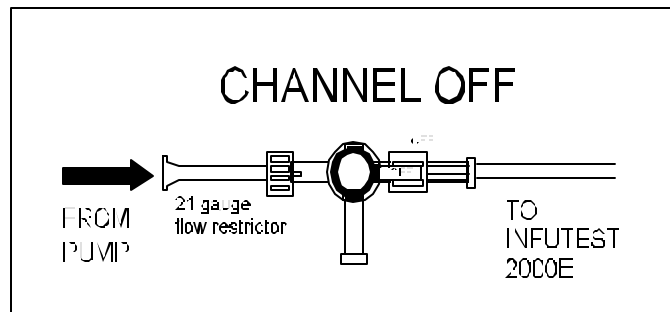


Figure 6 - Stop Cock position for channel OFF.

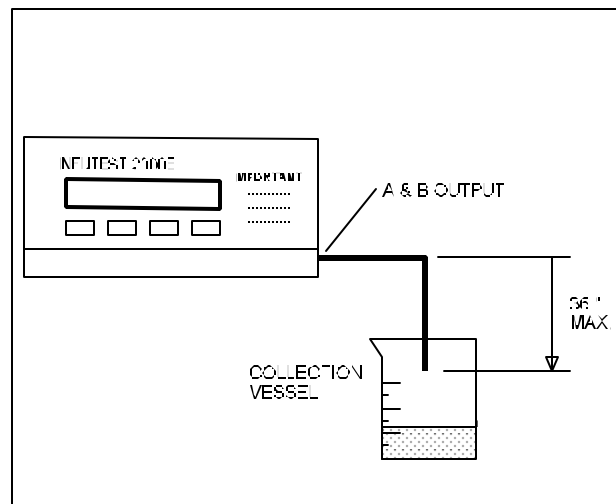


Figure 7 - Connection to A & B Output

**To prime a dry instrument:**

- a. Rotate the Channel A stop cock to PRIME (*Figure 5*) and the Channel B stop cock to OFF (*Figure 6*). Fill the 60 cc syringe supplied with the Infutest with 60 cc of **water**, connect the syringe to the open port on the Channel A stop cock and discharge the syringe into the fluid channel. Rotate the Channel A stop cock to OFF, and disconnect and refill the syringe. Repeat this priming action at least five times. Eventually, water will begin to drain out of the A & B Output, as air is forced out of the Channel A fluid system and reservoir.



## INFUTEST 2000E OPERATING MANUAL

- b. Now rotate the Channel A stop cock to OFF and the Channel B stop cock to PRIME. Repeat (a) above for Channel B.
- c. Prepare the device under test (DUT) by loading the device with an administration set and priming the set with **water** according to the manufacturer's instructions. Connect the primed set to the Channel A stop cock and set the stop cock to ON.
- d. Prepare a second DUT as above and connect it to Channel B.
- e. To test a single infusion device, connect the device to either Channel A or Channel B as desired and set the other channel's stop cock to OFF. This will prevent water from draining out the unused channel's input if any pressure is developed within the internal fluid system. If the input tubing set is not connected, the Delrin twistlock input connector has an internal seal which will prevent fluid backflow.
- f. If normal saline solution **must** be used as a test fluid (against Datrend's recommended practice), prime as described above and flush the channel with distilled water immediately following the test. **Under no circumstances should an instrument channel be used or left primed with saline for an extended period of time.**
- g. Unless the Infutest is stored for several months at a time, leave the instrument primed between uses. Following use, flush the Infutest with **distilled water**, set both channel stop cocks to OFF, and store the instrument in the horizontal position.

### **IMPORTANT:**

It is best to use a new administration set when testing an infusion device, or at least change the set periodically according to the manufacturer's recommendations. Use of IV sets which have or may have been used with saline, dextrose or other IV fluids should be avoided. See *section 2.3*, *Test Fluids*.

### **IMPORTANT:**

After powering-up, Infutest will attempt to obtain a zero pressure reference. To avoid a "pressure zero" alarm, ensure no pressure is applied at the Infutest inputs or output when applying power to the unit. Install the IV set *in* the DUT and leave the DUT on standby while the Infutest performs its self-test routines, to prevent a "pressure zero" alarm.

**IMPORTANT:**

When testing a syringe pump, always use a **new** disposable syringe. Prelubricate the syringe by drawing on the plunger a few times before loading the syringe with **water** and installing it in the pump.

After priming and connecting the administration set to a channel, always **flush the channel** before starting the test using a technique similar to that described to prime the Infutest. Injecting about 5 cc of water should be sufficient to remove any air bubbles in the channel. The Infutest reminds the user to do this via the LCD prior to starting a test.

If a test is already running on one channel, flush or prime the other channel by injecting water into it **gradually** rather than rapidly; discharge about 10 cc of water into the channel over 5 seconds. Gradually priming a channel in this way will prevent disturbances appearing on the other channel.

The Infutest may be used to test infusion devices immediately after priming both channels as described above. However, after shipping the Infutest, or following a period of dry storage, **optimum results are obtained if the internal flow sensors are first "wetted" before performing tests.**

The Infutest may be wetted by first priming the instrument, then running Single Rate Tests on Channels A and B at approximately 500 ml/hr for 10 to 15 minutes (refer to Section 4, *Operation and Related Displays*).

The preferred method of wetting, however, is to flush the instrument with Sudsy Ammonia solution and distilled water, following the cleaning procedure given in *Section 5.1.3, Cleaning*.

Wetting is optional, however, **cleaning** the instrument regularly is recommended, depending on usage. For instruments in daily use with distilled or domestic water, cleaning is recommended monthly. A thorough cleaning is essential if the instrument becomes contaminated with fluids other than water (dextrose, saline, etc.). The procedure for cleaning the Infutest and RSM is given in *Section 5.1.3, Cleaning*.

### 3.3 Optional Connections

- a. If complete test results are to be retained for documentation purposes, connect an Epson FX-compatible printer (80 columns and 66 lines per page, 80 characters per second) to the Infutest parallel Printer Port (*Figure 1*). The parallel Printer Port accepts a DB-25 male.
- b. As an alternative or in addition to (a) above, a personal computer (PC) or other data collection instrument may be connected to the Infutest Serial Port (*Figure 1*). The Infutest Serial Port is configured as *Data Communications Equipment (DCE)*, except that the Infutest Serial Port accepts a DB-25 female to distinguish it from the parallel Printer port.

Connect the Infutest to the COM port of a personal computer with a RS-232 cable having a DB-25 female at the Infutest end and a DB-25 (or DB-9) female at the computer end. Each pin on the computer's DB-25 connects to the *same pin* on the Infutest's DB-25; **do not** use a null modem adaptor or a null modem cable.

Alternatively, you may use a conventional computer-to-modem RS-232 cable with a double-female gender changer attached at the male end of the cable.

RS-232 cables for connecting the Infutest to a personal computer are available as accessories from Datrend Systems (See Section 1.7).

The Infutest Serial Port both transmits and receives, and is configured as follows:

**9600** baud, **No** parity, **8** bits/character, **1** stop bit.

Infutest - PC communications rely on hardware handshaking via the CTS lines. The Infutest holds the CTS line high continuously.

- c. The Infutest Serial Port may also be connected to an external controlling device to facilitate remote test control and data down loading. For example, the Infutest Serial Port may be connected to COM2 of a Fluke Biomedical medTester 5000C. Use of a SSC -1 accessory cable is recommended. The same CTS handshaking rules described above for the PC interface apply to external controllers such as the medTester.

## INFUTEST 2000E OPERATING MANUAL

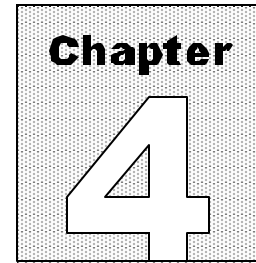
- d. The pin connections for the serial interface cables are as follows:

Infutest	Computer	
	DB25F	DB9F
2 (TXD)	2	3
3 (RXD)	3	2
4 (RTS)	4	7
7 (GND)	7	5

All other pin connections are open circuit.

- e. In order to download test results from the Infutest Serial Port, you must run a terminal emulator program on your PC (eg. Windows HyperTerminal). Datrend Systems can provide a Windows based software program (DTP) which has been specially designed for this purpose. In addition to the serial interface connection, DTP incorporates a number of additional utilities for viewing, editing and printing test data, or converting test data to spreadsheet or database compatible files, as well as producing Flow versus Time graphing, and Trumpet (error) graphs.

**INFUTEST 2000E OPERATING MANUAL**



# Operation

*This chapter describes the operation of the Infutest controls and the associated LCD screen displays. In addition, you are instructed how to modify the default settings and AutoSequence protocols.*

## 4. OPERATION AND RELATED DISPLAYS

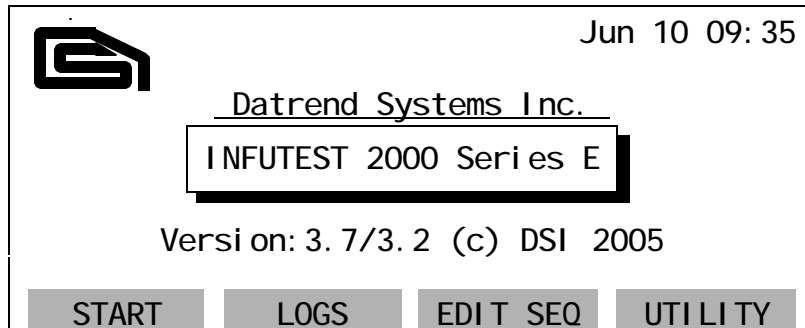
### 4.1 Powering Up and Setting the Clock

- a. Set the Infutest power switch on the rear panel (*Figure 1*) to ON. The Infutest LCD will display a power-up screen while performing a number of internal self-tests.
- b. If required, adjust the LCD contrast control on the rear panel (*Figure 3*) using a trimpot adjustment tool.
- c. If an abnormal condition is detected during the power-on self-test, the Infutest will report the fault by means of an alarm tone and message on the display. Refer to Section 4.9 - *Alarms*, if this should happen.
- d. Upon successful completion of the self-test, the screen illustrated in *Figure 8* will appear. The label displayed above each front panel key corresponds to the function of the key for the currently viewed screen. These keys are referred to as 'soft keys'.
- e. A real-time clock appears in the upper right hand corner of the LCD on most menus and screens as shown in *Figure 8*. The clock has 24-hour format and may be displayed as:

MONTH DAY hours:min  
DAY MONTH hours:min

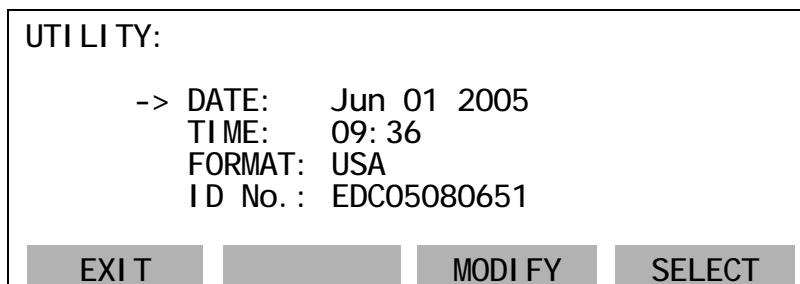
(USA) or;  
(EUR and ISO)

## INFUTEST 2000E OPERATING MANUAL



*Figure 8 - Power-on screen following successful self-test.*

- f. Press the LOGS soft key to recall previously acquired test results stored in the non-volatile Summary and Data Log; or,
- g. Press the EDIT SEQ soft key to create, edit and enable up to nine (9) automated test sequences. Refer to section 4.10 for complete instructions on the setup and use of automated sequence testing; or,
- h. Press the START soft key to set up and start a new test.
- i. Press the UTILITY key to display the screen of *Figure 9*, which allows setting of the internal time/date clock, or entry of a user-defined test equipment identification number for the Infutest.



*Figure 9 - UTILITY screen*

## INFUTEST 2000E OPERATING MANUAL

- j. To set the date, press the SELECT key until the → prompt is pointing to DATE : . Press MODIFY to change the DATE. The editing keys of *Figure 10* will then appear at the bottom of the screen.



*Figure 10 - DATE; TIME; and ID No. editing keys.*

- k. Press SELECT to move the editing cursor between the month, day and year displayed on the screen. Press SET+ to increment the highlighted item, or SET- to decrement the highlighted item. SET+ and SET- may be held down to continuously increment or decrement the selected item. Press ENTER to input the displayed DATE into the Infutest clock. The clock will support all dates for years 1999 through 2098, including Feb. 29 of leap years.
- l. Press SELECT to move the → prompt to the TIME : displayed on the screen. Press MODIFY to change the TIME. The editing keys of *Figure 10* will appear and will operate in a manner similar to setting the date. The clock employs a 24-hour format.
- m. Press SELECT to move the → prompt to FORMAT on the utility screen. Press MODIFY to select one of the three available formats for the clock date, as follows:

USA	Month-Day-Year
EUR(ope)	Day-Month-Year
ISO	Year-Month-Day
- n. Press SELECT to move the → prompt to ID No . on the utility screen. For Infutests shipped from the factory, the default ID No . is the unit serial number. If desired, press MODIFY to edit the ID number displayed on the screen. The keys will change to the editing keys of *Figure 10*, allowing each character of the ID No . to be changed individually. Up to 12 characters may be input using SET+ and SET-. Once editing is complete, press ENTER to save the ID No . in memory.

The ID No . shown on the utility screen is provided as a test equipment identification number, and as such will appear in each Test Summary or Data Log report printed or downloaded from the Infutest. This allows each test document to be traced to the Infutest which produced the document, a requirement for ISO 9000-compliant institutions and service providers.

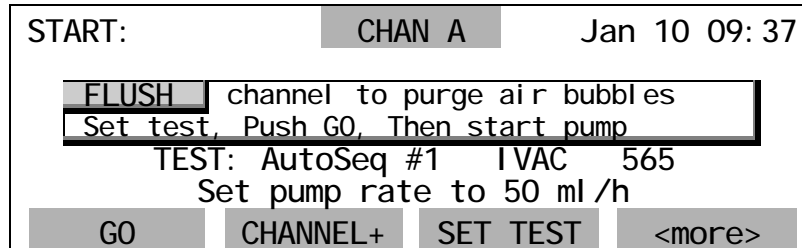


## INFUTEST 2000E OPERATING MANUAL

- o. Once the **DATE**, **TIME**, date **FORMAT** and Infutest **ID No.** have been set as desired, press the **EXIT** key to quit the utility function and return to the power-up screen of *Figure 8*. All utility settings will be retained in the battery-backed memory of the Infutest when the power is off.

## 4.2 Setting Up a Test

Pressing the **START** soft key on the power-up screen causes the **START** menu for Channel A to be displayed (*Figure 11*). This screen is used to select the particular test type or test AutoSequence before starting a test.



*Figure 11 - START menu, Channel A.*

- a. Press the **SET TEST** soft key to select one of four manual tests: Single Rate, Dual Rate, PCA Test or Occlusion Test; or one of up to nine AutoSequences. Auto Sequences must be enabled via the **EDIT SEQ** screen, before they can be selected using the **SET TEST** key.
- b. Each of the manual tests will run until **STOPped** by the operator. The AutoSequences can be set up to run a flow rate test, an occlusion test, and print or serially download the results automatically, to increase the test productivity.

### **Prior to starting a test, you may:**

- c. Press the **CHANNEL+** soft key to display a screen reflecting the current status of Channel B, C, or D; or,
- d. Press the **<more>**, then **EDIT SEQ** soft keys to access AutoSequence editing; or,
- e. Press the **<more>**, then **PREV TST** (Previous Test) soft keys to pre-empt the new test and recall results obtained from the last test executed on Channel A.
- f. A channel's Data Log and Summary are **NOT** erased until the "GO" key is input by the user via the **START** screen. At any time before this, the user may abort the start of a new test and recall the Summary and/or Data Logs for the previous test by means of the **PREV TST** soft key on the **START** screen.

## **4.3 Test Measurement Concepts**

The Series E Infutest introduces a number of new concepts to improve measurement accuracy and allow Infutest to more readily deal with pulsatile pumps.

### **4.3.1 SynchroStart**

When a test is started, the Infutest prompt reads “Push GO, then start pump”. At first, this may seem backwards, however, Infutest will not start its first measurement until *after* it detects actual fluid flow. This synchronizes the flow measurements with the beginning of fluid flow, which is important on pumps which have a pulsatile flow pattern.

### **4.3.2 End-of-Infusion Analysis**

End-of-Infusion Analysis (EIA) calculates the volume infused at the instant the STOP key is depressed, or the automatic sequence reaches the end of the preset test time. The only caveat with this calculation is it will be in error if the pump is stopped before the test is stopped. To bring this to the user’s attention, the “Volume Infused” displayed on SUMMARY screens will flash on and off to remind the user that this value *may* be in error. If there is any question about the accuracy of this value, the full test DATA LOG may be reviewed, and the second last value used.

### **4.3.3 Flow Pattern Classification**

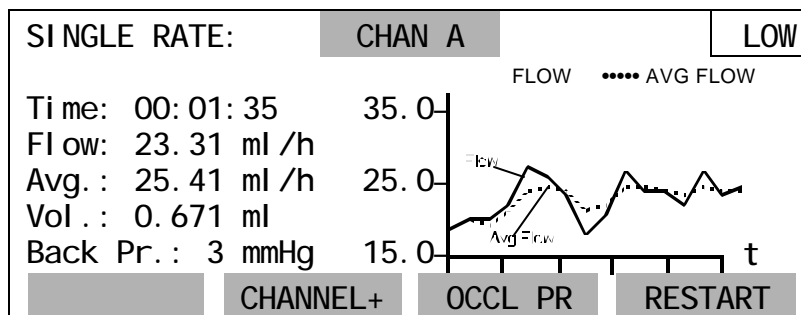
Different flow measurement algorithms are used, based on the type of flow pattern detected. During initial flow detection, and continuously thereafter, the flow pattern is analyzed to determine if it is smooth, pulsatile or very pulsatile. The flow pattern classification is indicated on the display in the STATUS indicator on the upper right corner of the screen. If the flow is smooth and continuous, the STATUS indicator will be LOW or HI, depending on the rate. If the flow is delivered in very small ‘spurts’ the indicator will be PUL. If the flow is delivered in large pulses (as in many home care pumps) the indicator will be VPF, and the rate will be measured on the HI range sensor. This may increase the flow measurement times for pulsatile pumps measured at low flow rates.

## 4.4 Starting a Test

Following the prompts on the START screen, the flow sensor for the channel in use should be primed, then simply press the GO soft key and start the infusion pump to begin the test. **The infusion pump under test does not need to be started until the GO key has been pressed. If the pump has an unusual, high flow condition that appears only on startup, the pump may be started first. This may avoid the automatic selection of the high range flow sensor when the pump is running at low rates.**

## 4.5 Running a Test

A running test will produce a display similar to that illustrated in *Figure 12*. As shown in the figure, the top line of the TEST screen is reserved for the name of the test on the left (SINGLE RATE; DUAL-RATE; PCA PUMP; or OCCL. PR.), the channel identifier label in the center (CHAN A or CHAN B), and the current test status on the right (BOLUS#, or RATE #; plus the flashing flow status indicator: one of LOW, HI, PUL, VPF, or LOCKOUT).



*Figure 12 - TEST screen for Single Rate Test, Channel A.*

The definitions of the displayed mnemonics on the left half of the screen are:

**Time:** is the total time elapsed since the start of the test, in hours, minutes and seconds (hh:mm:ss).

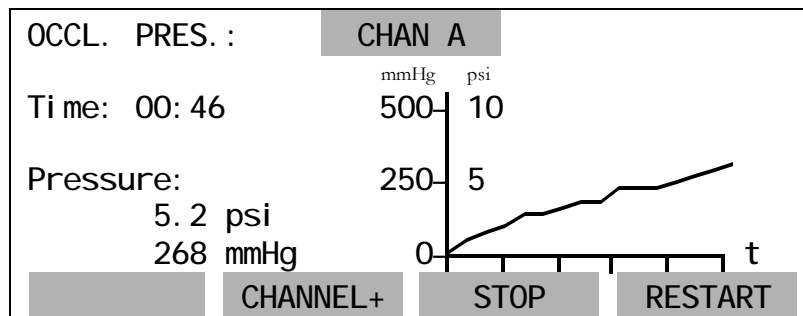
For Single Rate, Dual-Rate, and PCA Pump Tests...

**Flow:** is the "instantaneous" flow rate in milliliters per hour, obtained by measuring a small volume of effused test fluid over a fixed interval of time, ranging from a minimum of 4 seconds to a maximum of approximately 10 minutes.

## INFUTEST 2000E OPERATING MANUAL

- Avg. :** is the average flow rate from the start of the test, in milliliters per hour, derived by calculating the ratio of the total effused volume to the total elapsed time.
- Vol. :** is the total volume of fluid which has been effused through since the test was started, in milliliters.
- Back Pr. :** is the back pressure in mmHg appearing at the input, which is approximately equal to the positive pressure optionally applied by the user at the Infutest A&B Output to oppose the flow from the infusion device (see Appendix A, *Back Pressure Testing*).

For the Occlusion Pressure Test, the TEST screen will appear as in *Figure 13*.



*Figure 13 - TEST screen for an Occlusion Pressure Test, Channel A*

- Pressure:** is the pressure obtained at the input at time mm:ss, after the channel has been internally occluded, in units of psi and mmHg.

The right half of the TEST screen is reserved for the real-time graph of either instantaneous and average flow, or occlusion pressure. The vertical axis is scaled automatically based on graph type and initial measurement data. Rather than absolute time in minutes, the horizontal 't' axis represents time in number of measurements, each tick indicating three consecutive data points. As the test proceeds, the graph scrolls to display data from the most recent 15 measurements.

The top right corner of the TEST screen is reserved for displaying test status messages and the blinking flow status indicator, which indicates the test is in progress. The Dual-Rate, PCA Pump and Occlusion Pressure Tests have a number of status messages which appear at this location in addition to the flow status indicator shown in *Figure 12*.

## INFUTEST 2000E OPERATING MANUAL

These status messages are:

<b>Test</b>	<b>Status Message</b>
Dual-Rate	RATE #N - the infusion device is currently operating at preprogrammed flow rate number N, where N = 1 or 2.
	WARNING! - PUL the infusion device produces pulsatile flow. Switch from RATE #1 to RATE #2 will not be detected. Flow and volume measurements may be low (see Section 5.3.5).
PCA Pump	BOLUS #NNN - The triggered delivery of bolus number NNN from the PCA pump is in progress or has been completed, NNN = 1 to 255. After delivery, the average delivery rate and the volume of the bolus are posted beside the "Avg.:" and "Vol.:" labels respectively.
	WARNING! - PUL the infusion device produces pulsatile flow. Flow and volume measurements may be low (see Section 5.4.3).
	MM:SS [flow status indicator = Lockout] The lockout time between bolus deliveries number NNN and number NNN+1 measured in mm:ss [minutes and seconds.]

The screen shown in *Figure 12* is for an AutoSequence test, with an occlusion pressure test enabled. In a manually selected test, or if the pressure test has not been enabled in the AutoSequence, the OCCL PR soft key will read STOP. To operate the Infutest, proceed as follows when viewing the TEST screen:

- a. Press the RESTART soft key to cause the test or AutoSequence to abort, and return to the START screen.
- b. Press the CHANNEL+ soft key to cause a Channel B screen to be displayed; if the channel is not running a test the Channel B START screen will appear, allowing the user to set up and start a test on Channel B (see Section 4.2, *Setting Up a Test*).
- c. Press the STOP soft key to cause the test to stop running and the SUMMARY screen to be displayed; or, if the OCCL PR soft key is displayed, press it to jump to the occlusion pressure portion of the automatic test sequence. In the occlusion pressure test screen, *Figure 13*, the operator will be presented with the STOP soft key to end the test prior to the preset time of the AutoSequence, and start the automatic data output - if data output is enabled.

## 4.6 Viewing the Test Summary

### 4.6.1 SUMMARY Screen for Single-Rate Test

*Figure 14* is a SUMMARY screen for a Single Rate Test performed on Channel A. The definition of the mnemonics displayed on the screen is:

**Test:** is the type of test that was executed (SINGLE RATE; DUAL-RATE; PCA PUMP; or OCCLUSION PRESSURE). If an Occlusion Pressure Test was enabled in an AutoSequence for a Single Rate, Dual-Rate or PCA Pump Test, the label "**+ OCCL PRESSURE TEST**" will appear with the title of the initial test as shown in *Figure 14*.

**Infusion**

**Time:** is the duration of the test, in hours, minutes and seconds

**Volume**

**Infused:** is the total volume of test fluid that was effused during the test, in milliliters

**Average**

**Rate:** is the flow rate averaged over the duration of the test, in milliliters per hour

**Back**

**Pressure:** is the back pressure measured at the end of the test, in mmHg

SUMMARY:	CHAN A	Jan 10 09: 51
SINGLE RATE + OCCL PRESSURE TEST		
Infusion Time:	00: 16: 01	
Volume Infused:	2. 642 ml	
Average Rate:	9. 900 ml /h	
Back Pressure:	5 mmHg	
OUTPUT	CHANNEL+	OCCL PR
		START

*Figure 14 - SUMMARY screen for Single Rate plus Occlusion Pressure Test, Channel A.*

The SUMMARY screen shown in *Figure 14* is from an AutoSequence with an Occlusion Pressure test enabled. In this case, pressing the OCCL PR key displays the summary for the Occlusion Pressure test (see Section 4.6.4). For manually run Single Rate, Dual-Rate or PCA pump tests, or if the occlusion test is not enabled in the AutoSequence, the OCCL PR key is labelled DATA. Pressing the DATA key displays the contents of the data log.

**4.6.2 SUMMARY Screen for Dual-Rate Test**

The SUMMARY screen for a Dual-Rate Test is shown in *Figure 15*.

SUMMARY:	CHAN B	Jan 10 10: 21
DUAL RATE TEST		
	RATE #1	RATE #2 Back Pr:
Inf. Time:	00: 02: 08	00: 01: 26 1 mmHg
Vol . Inf. :	1. 604 ml	0. 116 ml
Avg. Rate:	45. 09 ml /h	4. 905 ml /h
OUTPUT	CHANNEL+	DATA START

*Figure 15 - SUMMARY screen for Dual-Rate Test, Channel B.*

As with the Single Rate Test, if an Occlusion Pressure Test is started by an AutoSequence, the DATA soft key will be replaced by OCCL PR . Pressing the OCCL PR key will access the pressure summary screen.

If the user chooses to stop a Dual-Rate Test before the infusion device switches to Rate #2, no values will appear on the right half of the SUMMARY screen.

**4.6.3 SUMMARY Screen for PCA Pump Test**

The SUMMARY screen for a PCA Pump Test is shown in *Figure 16*. The data displayed are averages, calculated from the individual values of each of the respective measurements, from the beginning of the test. If a [?] appears at the end of the ‘Average Bolus Volume’ line, this indicates that one or more individual bolus volumes has exceeded the first measured bolus by +/- 10%. Similarly, a [?] on the ‘Average Lockout Time’ line indicates a variation in excess of +/- 10% in the measured lockout times, with the first lockout time used as a reference. To review the complete data for the test, press the DATA soft key to access the complete log of measurement data.



SUMMARY:	CHAN A	Jan 10 10: 29
P. C. A. PUMP TEST		
Average Bolus Volume:	1.438 ml	[?]
Average Delivery Rate:	92.68 ml/h	
Average Lockout Time:	05:02 mm:ss	[?]
Number of Deliveries:	3	
OUTPUT	CHANNEL+	DATA      START

Figure 16 - SUMMARY screen for PCA Pump Test, Channel A.

The 'Number of Deliveries' refers to the number of *complete* bolus deliveries. If a test is STOPped during a lockout time measurement, the 'Number of Deliveries' will include the last bolus measured.

#### 4.6.4 SUMMARY Screen for Occlusion Pressure Test

The SUMMARY screen for an Occlusion Pressure Test, initially selected on the SETUP menu or executed as part of an AutoSequence for a Single Rate, Dual-Rate or PCA Pump Test, is shown in *Figure 17*.

SUMMARY:	CHAN B	Jan 10 11: 02
OCCLUSION PRESSURE TEST		
Max. Occlusion Pr.:	3.6psi	186 mmHg
measured at time:	00:52 mm:ss	
OUTPUT	CHANNEL+	DATA      START

Figure 17 - SUMMARY screen for Occlusion Pressure Test, Channel B.

The summary screen will include one of the following:

**Max.**

**Occlusion Pr:** is the maximum pressure detected, during the test, in psi and mmHg. The time displayed corresponds to the time of the detected maximum.

## INFUTEST 2000E OPERATING MANUAL

### **Nrs Call**

**Alarm Pr.:** is the pressure measured at the time the nurse call signal was activated. The time displayed also coincides with the detection of the nurse call signal.

### **Overpressr**

**Reading:** indicates that the maximum system pressure of 50 psi was exceeded during the test, and the test was terminated. The time displayed corresponds to the time of the overpressure condition.

## **4.6.5 SUMMARY Screen Usage**

Operate the Infutest as follows when viewing the SUMMARY screens shown in *Figure 14* to *Figure 18*:

- a. Press the OUTPUT soft key to cause the channel's output submenu to be displayed. This menu may be used to output the Summary and/or Data Log to either the printer or serial port; or,
- b. Press the CHANNEL+ soft key to cause the next channel's screen to be displayed; if the channel is not running a test the channel's SETUP menu will appear, allowing the user to set up and start a test on the channel (see Section 4.2, *Setting Up a Test*); or,
- c. Press the DATA soft key to cause the channel's Data Log sub-screen to be displayed. This screen allows the user to scroll through the raw data which was acquired during the test. If an occlusion pressure test was performed as part of an AutoSequence, the DATA key will be replaced with OCCL PR. The DATA selection will then be available from the Occlusion Pressure Summary screen; or,
- d. Press the START soft key to return to the START menu to set up and start a new test. If this key is pressed accidentally, the SUMMARY screen may be restored by means of the PREV TST soft key on the channel's START/<more> screen.

## 4.7 Viewing the Data Log

### 4.7.1 Data Log Description

Measurements acquired during a test and displayed on the TEST screen are saved in the Data Log. The Data Log is non-volatile and has a maximum capacity of 900 flow measurements per channel (450 measurements in four-channel mode). This corresponds to approximately **2 hours and 15 minutes** of Single Rate Test data at a flow of 100 ml/hr. The pressure Data Log may hold up to 700 data points (350 in four-channel mode).

The Data Log is based on a **circular memory**, which means that after the Data Log has been filled up with 900 flow measurements, the Infutest data logger will continue to save newly acquired flow data in the Data Log by **overwriting** the oldest data, that is, the data which was first acquired at the start of the test. This will continue until the user stops the test. The Data Log therefore retains the most recently acquired 900 flow measurements. Similarly, the most recent 700 pressure measurements will be maintained in the pressure Data Log.

For longer tests of more than 900 measurements, the Infutest provides real-time data output through the use of the computer interfacing commands (IRC). In this case, all measurements obtained may be sent both to the Data Log and to the Serial Port.

### 4.7.2 DATA Screen Usage

Pressing the DATA soft key of the SUMMARY screen will cause the channel's Data Log to be displayed in tabular format as shown in *Figure 18*. The DATA screen allows the user to scroll line by line through the contents of the channel's Data Log. The XX.XX illustrated in the example of *Figure 18* represent arbitrary numerical data.

**INFUTEST 2000E OPERATING MANUAL**

DATA:		CHAN A		
El apsed Ti me	Fl ow (ml /h)	Avg Fl ow (ml /h)	Vol ume (ml )	B. Pres (mmHg)
hh: mm: ss	XX. XX	XX. XX	X. XXX	XXX
hh: mm: ss	XXX. X	XX. XX	X. XXX	XXX
hh: mm: ss	XX. XX	XX. XX	X. XXX	XX
hh: mm: ss	XXX. X	XXX. X	X. XXX	XX
SUMMARY			SCROLL+	SCROLL-

*Figure 18 - Data table for Single Rate, Dual Rate, and PCA Pump Tests; no event markers.*

- Press the SCROLL+ soft key to scroll forward through the Data Log line by line. If the key is pressed and held, the data will continuously scroll until the key is released
- Press the SCROLL- soft key to scroll backward through the Data Log line by line. If the key is pressed and held, the data will continuously scroll until the key is released
- Press the SUMMARY soft key to return to the SUMMARY screen.
- While scrolling through the log with the SCROLL+ and SCROLL- soft keys, event markers will appear in-line with the numerical data for the Dual-Rate, PCA Pump and Occlusion Pressure Tests. Refer to **Figure 19** for an example of BOLUS and LOCKOUT event markers which are inserted into the Data Log of the PCA Pump Test.

DATA:		CHAN A		
El apsed Ti me	Fl ow (ml /h)	Avg Fl ow (ml /h)	Vol ume (ml )	B. Pres (mmHg)
hh: mm: ss	XX. XX	XX. XX	X. XXX	X
LOCKOUT TIME = 06:01				
BEGIN BOLUS # 2				
hh: mm: ss	XXX. X	XXX. X	X. XXX	X
SUMMARY			SCROLL+	SCROLL-

*Figure 19 - Data table for PCA Pump Test, showing BOLUS and LOCKOUTTIME event markers.*

**INFUTEST 2000E OPERATING MANUAL**

- e. If an Occlusion Pressure Test was conducted manually, or as part of an AutoSequence, the DATA screen will appear as shown in *Figure 20*.

DATA:		CHAN A	
El apsed Ti me	Occl usi on	Pressure	
	(psi )	(mmHg)	
00: 00: 02	0. 0	0	
00: 00: 04	0. 1	5	
00: 00: 06	0. 2	10	
00: 00: 08	0. 3	15	
SUMMARY		SCROLL+	SCROLL-

*Figure 20 - Data table showing Occlusion Pressure Test data.*

- f. When the DATA screen has been scrolled to the end of the Data Log, the END OF LOG message will be displayed as shown in *Figure 21*.

DATA:		CHAN A		
El apsed Ti me	Fl ow (ml /h)	Avg Fl ow (ml /h)	Vol ume (ml )	B. Pres (mmHg)
hh: mm: ss	XX. XX	XX. XX	X. XXX	X
END OF LOG				
SUMMARY		SCROLL+	SCROLL-	

*Figure 21 - Data table showing the end of the Data Log has been reached.*

## 4.8 Output of Summary and Data Logs

Pressing the OUTPUT soft key on a channel's SUMMARY screen causes the OUTPUT submenu for the channel to be displayed (*Figure 22*). This submenu is used for sending the Summary and/or Data Log to either the parallel Printer Port or the Serial Port, or both, if desired.

- a. To set the type of report to be output, press the SELECT key until the → prompt is pointing to REPORT: . Press MODIFY to change the report type to "Summary"; "Data Log"; or "Port Tst".

OUTPUT:	CHAN A		
REPORT:	Summary	<-	ID TYPE: Contrl No.
PORT:	Printer		PUMP ID: ECN1234567
STATUS:	READY		
SUMMARY		GO	MODIFY
			SELECT

*Figure 22 - OUTPUT submenu*

With REPORT set to "Summary", a Test Summary Report, which will list the contents of the Summary Log, will be output to the selected PORT. If REPORT is set to "Data Log", the entire contents of the Data Log (up to 2000 lines of measurement data) will be output to the selected PORT. If REPORT is set to "Port Tst", two lines of characters will be sent to the selected PORT, allowing the user to ensure the receiving device is on-line and functioning as expected.

- b. Press SELECT so that the → prompt moves to the "PORT:" parameter. Press MODIFY to select either "Printer" or "Serial" as the output destination. If the selected PORT is not already busy outputting data, the STATUS line will indicate READY as shown in *Figure 22*.
- c. Press SELECT so that the → prompt moves to the "ID TYPE:" parameter. Press MODIFY to select either "Control No.", "Serial No.", or "None" as the pump ID TYPE.

## INFUTEST 2000E OPERATING MANUAL

The ID TYPE refers to the pump being tested, and allows the user to enter either the serial number or control number of the pump on the "PUMP ID:" line. If the ID TYPE is set to "Control No." or "Serial No.", the PUMP ID will appear in the appropriate area of the report when the Summary or Data Log is printed or downloaded from the Infutest. If there is no desire to include a pump serial number or control number in the report document, press MODIFY to set the ID TYPE to "None".

- d. If "ID TYPE" has been set to either "Control No." or "Serial No.", press SELECT so that the → prompt moves to the "PUMP ID:" parameter. Press MODIFY to edit the displayed PUMP ID. The keys will change to the editing keys of *Figure 23*, allowing each character of the PUMP ID to be changed individually. Up to 10 characters may be input using SET+ and SET-. Note that SET+ and SET- may be held down to continuously scroll through the character set. Once editing is complete, press ENTER to save the PUMP ID in memory.



*Figure 23 - PUMP ID editing keys*

- e. The PUMP ID is continuously retained in the battery-backed memory of the Infutest with power on or power off, until the ID is changed by the user. To prevent the displayed PUMP ID from appearing in the Summary or Data Log output without actually editing or erasing the PUMP ID, simply set ID TYPE to "None".
- f. If output to a personal computer via the Infutest Serial Port is desired, the user must first run a terminal emulation/communication program after connecting the Infutest to one of the PC's COM ports. Set up the COM port as follows:

**9600 baud, No parity, 8 bits/character, 1 stop bit**

Ensure that the correct COM port on the PC has been selected, otherwise the download will not be initiated. Refer to *Section 3.3* for complete serial interface details.

- g. Once the REPORT, PORT, ID TYPE and, if applicable, the PUMP ID have been set as desired, press GO to initiate the printout or download of the Summary or Data Log report.

## INFUTEST 2000E OPERATING MANUAL

- h. The data output system incorporates an output queue to handle all data output. If the Infutest is already outputting data on either the serial or parallel port, the STATUS line will read BUSY, and the GO soft key will be changed to QUEUE. Pressing the QUEUE key will place the output job into the output queue and the STATUS line will change to QUEUED. If there is nothing already in the output queue, pressing the GO key will change the STATUS line to PRINTING or DOWN LOADING, depending on the output port selected. Refer to *Figure 24* for an example of an output screen.

OUTPUT:	CHAN A		
REPORT: Summary <-	ID TYPE: Contrl No.		
PORT: Printer	PUMP ID: ECN1234567		
STATUS: PRINTING			
SUMMARY			CANCEL

*Figure 24 - OUTPUT submenu showing print job in progress.*

- i. To **terminate** an **output** job in progress, press the CANCEL key.
- j. The Infutest will detect if the Printer is off-line within approximately 10 seconds. For the case of the Printer being off-line or out of paper, an alarm tone will be produced and the STATUS line will appear as shown in *Figure 25*. As instructed by the screen, press the O.K. soft key when the problem has been corrected, or press KILL ALL to abort the selected output job(s).

OUTPUT:	CHAN A		
REPORT: Summary <-	ID TYPE: Contrl No.		
PORT: Printer	PUMP ID: ECN1234567		
STATUS: Printer OFF LINE			
Push O.K. when ON LINE			
KILL ALL			O.K.

*Figure 25 - OUTPUT submenu showing Printer is off-line.*



## INFUTEST 2000E OPERATING MANUAL

- k. When the selected output job is complete, the OUTPUT screen will return to its initial state as illustrated in *Figure 22*. The user may now modify the OUTPUT and SEND TO parameters to output additional copies of the Summary or the Data Log to either the Printer or Serial Port as desired.
- l. Output jobs are run as background processes. After pressing the GO (or QUEUE) soft key, the user may press the SUMMARY soft key and then recall other screens while the Infutest outputs to the Printer Port or Serial Port.
- m. An example of a Test Summary Report corresponding to the OUTPUT screen is provided in *Figure 26*. Note that each report output from the Infutest will include blanks at the bottom for the technician's name and signature.

p. 01

INFUTEST 2000-E  
Datrend Systems Inc.

TEST SUMMARY REPORT

Start of Test - Date: Aug 01 2005  
                  - Time: 09: 38

Infusion Device Information:

Manufacturer: \_\_\_\_\_ Model: \_\_\_\_\_

Serial No.: \_\_\_\_\_ Control No.: ECN1234567

Department: \_\_\_\_\_ Location: \_\_\_\_\_

Set Rate(s): \_\_\_\_\_ ml/h VTBI: \_\_\_\_\_ ml

Infutest ID: EDC05080651  
Channel: A

SINGLE RATE TEST

  Infusion Time: hh:mm:ss  
  Volume Infused: VVVV ml  
  Average Rate: RRRRR ml/h  
  Back Pressure: PPP mmHg

Tech: \_\_\_\_\_ Signature: \_\_\_\_\_

*Figure 26 - Format of Summary Report printout .*

## **4.9 Alarms**

On power up, Infutest may detect an alarm condition which may or may not indicate the need for service. The alarm message screen will appear following the self test screen. Most **FAULT** conditions will require factory service, while **WARNING** conditions will require a user action, but should not prevent the use of the instrument.

### **4.9.1 Nonrecoverable Alarms**

The following **FAULT** conditions will require the unit to be returned to the factory or authorized service center for service:

<b>FAULT: TCO SCI</b>	Serial Communications Error
<b>FAULT: TCO RAM</b>	Memory Error - RAM
<b>FAULT: TCO ROM</b>	Memory Error - ROM
<b>FAULT: TCO EPM</b>	Memory Error - EEPROM

### **4.9.2 Recoverable Alarms**

The following **WARNING** and **FAULT** conditions will require user action before proceeding, but should not prevent the use of the instrument for testing:

**WARNING: UNIT UNPRIMED**

Both flow sensors are completely dry and **MUST** be primed with water before a test can be initiated. This will normally only appear after extended periods of storage with no fluid in the sensors (i.e. after delivery of unit from dealer).

**WARNING: NVRAM ERROR**

The data and clock backup battery on the unit may be too low to retain data on power down, or the clock may be incorrect. The instrument will operate correctly, however, the data in the Data Log may be corrupted when the power is turned off, or the time and date in the tests may be incorrect. The battery should be replaced at the earliest opportunity.

## INFUTEST 2000E OPERATING MANUAL

### FAULT: Pressure/Vacuum Applied to unit

When the power was applied, the pressure at the input (or output) was either too high or too low to be zeroed out by the internal pressure zero circuitry.

This could be caused by incorrect positioning of the collection container or by a pump running at the input while the output is blocked.

Remove the cause of the pressure or vacuum and re-power the unit.

If the Infutest is left in a partially primed state (e.g. the glass and tubing are filled with sections of air and small columns of water) simply connecting then disconnecting a collection vessel to the O/P may result in enough pressure being applied then stored in the system to cause a fault when the unit is powered on and the self test is performed.

There are two methods for clearing the fault and removing the pressure.

One method is to release the pressure by opening the I/P shutoff valve. This can be accomplished by connecting the appropriate coupling to the I/P shut off valve thus releasing the pressure. The applied coupling may not be connected to an Infusion pump or any other device, it must be open to atmosphere.

The second method is to prime the unit and then remove any connections to the I/P and O/P couplings.

In either case, re-power the unit.

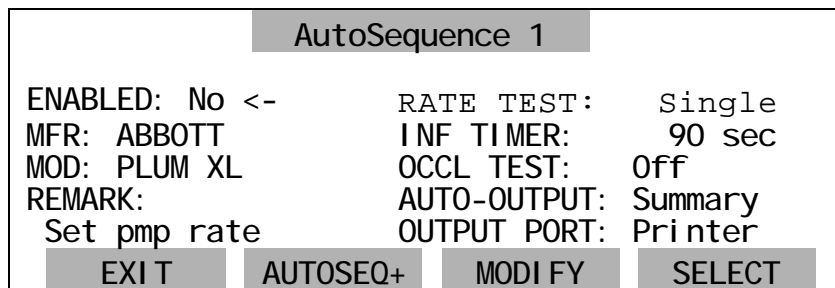
### FAULT: TCO/SCI Serial Communications Error

When unit power is rapidly cycled on and off this message *may* be displayed on some units. Shut the unit off for a minimum of 30 seconds before attempting to power up the unit. If the error persists, contact Datrend Customer Service with the unit serial number for further instructions.

## **4.10 AutoSequences**

To assist in standardizing test protocols, the Infutest provides nine (9) user programmable autosequences. An AutoSequence defines a series of steps that the user would normally perform on a given make of infusion pump. The steps consist of a timed flow rate test [single rate, dual rate or PCA], a timed occlusion pressure test and an automatic output to either the serial or printer port. Six pump test protocols have been preprogrammed as examples of how the AutoSequence testing is setup. These tests may be overwritten or modified based on the user's needs. Any changes made to the autosequences are retained in nonvolatile memory for future use.

To enter the AutoSequence Editor, select **EDIT SEQ** from either the power up screen, following the system self test, or the **START** screen during normal operation. The sequence editing screen is shown in *Figure 27* and provides access to all of the test parameters that make up a test sequence. The arrow (<- or ->) points to the parameter to be modified or edited, and may be moved using the **SELECT** key.



*Figure 27 - AutoSequence editing screen.*

The definition of the prompts displayed on the screen are:

**ENABLED :**

Determines if the test sequence will be available in the series of tests selectable for each channel. The factory default setting is 'NO', which disables the autosequences. Press the **MODIFY** key to change the setting.

## INFUTEST 2000E OPERATING MANUAL

### MFR :

The pump manufacturer's name may be keyed into this space (or any other prompt you wish). The MFR parameter is seven characters long and may be changed by pressing the MODIFY key when the arrow (<-) points to the MFR line. On entering the text editor, the display of *Figure 28* will appear, with the first character of the text highlighted. To change the highlighted character, press SET+ or SET- to scroll through the available character set. If the key remains pressed, the scroll will be continuous until it is released. When the correct character is found, press SELECT to move to the next character. When all the characters have been selected, press ENTER to return to the main sequence editing screen.

### MOD :

The model of the pump may be optionally inserted or edited when the arrow points to this parameter. The MOD parameter is seven characters long and is edited as described in the MFR section.

AutoSequence 1			
ENABLED: Yes	RATE TEST:	Single	
MFR: ABBOTT <-	INF TIMER:	90 sec	
MOD: PLUM XL	OCCL TEST:	Off	
REMARK:	AUTO-OUTPUT:	Summary	
Set pmp rate	OUTPUT PORT:	Printer	
ENTER	SET-	SET+	SELECT

*Figure 28 - Text editing screen.*

## INFUTEST 2000E OPERATING MANUAL

### REMARK :

The remark entry consists of 24 characters and is generally a user prompt which will appear on the test START screen. It is intended as a reminder to the user to set the pump to a specific rate, VTBI, etc. before the test is begun. The REMARK is presented as two lines of twelve characters in the sequence editor, in order to fit on the screen. Each of the two - 12 character segments will flash alternately on the screen until the text editor is chosen. When editing the remark, the first twelve character segment will be displayed, with the first character highlighted. As described under MFR, each highlighted character may be changed with the SET+ or SET- keys, and the character to change is chosen with the SELECT key. When the last character of the twelve character segment is highlighted and the SELECT key is pressed, the second twelve character remark segment will be presented for editing. When the remark is complete, press ENTER to accept the new text.

### RATE TEST :

The rate test parameter has four preset options: Single, Dual, PCA and None. With the arrow (->) pointing at RATE TEST, press MODIFY to change the type of flow rate test desired. The 'None' option allows the selection of an occlusion test alone, if desired. Depending on the RATE TEST selected, other parameters may change for consistency in the logic. (ie. 'None' will turn the timer 'Off')

### INF TIMER :

The infusion timer parameter sets the time limit for the rate test, and should be calculated based on the desired rate and volume to be infused for the pump test protocol. For instance, if the protocol recommends setting the pump to 400 ml/hr and the volume to be infused to 10 ml, the test time would be  $((10 \text{ ml}/400 \text{ ml/hr}) * 3600) = 90 \text{ sec}$ . The infusion time may be changed by pressing the MODIFY key. The timer edit screen works the same as the text edit screen, except the available characters are limited to the numerical values 0-9. The maximum time selectable is 9999 sec (167 min).

## **INFUTEST 2000E OPERATING MANUAL**

### **OCCL TEST :**

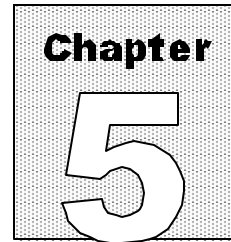
The occlusion test parameter has ten preset options: 0.5 min, 1 min, 2 min, 3 min, 5 min, 10 min, 20 min, 30 min, 50 min, and Off) The time required for an occlusion test will depend on the flow rate and the occlusion pressure limit set on the pump. Some experimentation may be required in setting up this parameter. For each of the factory preset sequences, the occlusion test has been turned off.

### **AUTO-OUTPUT :**

The test results may optionally be automatically output to the printer or the serial port at the end of the test. There are three preset options: Summary, Log and Off. If a test finishes while another channel is outputting data to the selected port, the test results will be placed in the output queue, as described in section 4.8 *Output of Summary and Data Logs* .

### **OUTPUT PORT :**

As described above, the test results may optionally be automatically output to the printer or the serial port at the end of the test. If an automatic output has been enabled, the output port may be selected from either the 'Printer' or the 'Serial' port. If the automatic output has been turned off, the output port will indicate 'None', and cannot be modified.



## Test Usage

*This chapter discusses the basic guidelines that should be followed to ensure good test results. Also discussed are the test methods to follow for each of the test types, and typical usage criteria.*

### 5. TEST USAGE GUIDELINES

#### 5.1 General Rules

##### 5.1.1 Test Fluids

Infutest must be used with the right test fluid to ensure accuracy of the measurements displayed and to promote longevity of the internal valves and flow sensors. Here are some recommendations regarding the use of various fluids in the Infutest.

##### a. Use distilled water

Distilled water may be obtained in bags or bottles from several areas in your hospital (e.g. pharmacy, stores). If your hospital does not stock plain distilled or "sterile" water in a convenient container, you may buy a gallon jug which may provide enough distilled water to supply several months of PM testing.

The advantage of using distilled water is you may keep your Infutest set up and primed all the time without damaging the internal valves or flow sensors. Outgassing is less likely to occur with room temperature distilled water than with cold water drawn directly from the tap.

Infutest is calibrated using distilled water as the test fluid. For this reason, you should also use distilled water as the test fluid if you want to get maximum accuracy from your Infutest.

Distilled water may be left in the Infutest for months (or even years) without damaging the internal sensors or causing rusting of the valves.



**b. Use tap water with caution**

Water drawn from the cold faucet is an acceptable test fluid provided it is "soft" (low mineral content), clean and perfectly clear. Do not use water from the hot tap as foreign material from your building's water heater may damage the Infutest's flow sensors.

Tap water that's been left open to air may collect dust and dirt, and may even grow algae if exposed to sunlight. To maintain cleanliness, tap water should be kept in an enclosed vessel and should be replaced daily.

If you use water from the tap, collect the (cold) water in a clean container and leave it for a few hours to de-gas and warm up to room temperature. It is also good practice to pass tap water through a domestic water filter before use (for example, a Brita filter).

**c. DON'T use coloured water**

The Infutest's flow sensors incorporate optoelectronics which are calibrated to detect transparent (i.e. distilled) water. Using water mixed with food dye or other colouring may cause Infutest to display erroneous flow and volume measurements. Dyes may also stain the tubing and fittings of Infutest's internal fluid system, which will *void the warranty*.

**d. DON'T use saline**

You may use normal saline (e.g. 0.9% Sodium Chloride Injection USP) if you must, but you may damage the Infutest if you don't flush out the fluid channel thoroughly with distilled water immediately after testing the pump.

*Never* use saline to test a pump and then leave the saline in the instrument, or simply drain the Infutest and store the instrument away on the shelf. Since Infutest's occluder valves are made of magnetic stainless steel, exposure to both salt water droplets and oxygen will eventually cause the valves to rust. At this point you will find you can't prime the Infutest, or you can't perform the Occlusion Pressure Test.

*Damage to the Infutest's valves from use of saline as a test fluid is not covered under warranty.*

e. **DON'T use D5W, D25W, or D50W**

The Infutest's flow sensors are designed and calibrated to work with distilled water. D5W, D25W and similar dextrose solutions, in addition to being too viscous, leave a sticky residue in the glass tubes of the flow sensors which prevents proper operation.

*Never* allow dextrose or TPN solution to get into the Infutest. If you do, Infutest will probably display erratic and/or erroneously low measurements. You will then have to clean the sticky material out of the Infutest's flow sensors (see Section 5.1.3).

*Contamination of Infutest's fluid system from use of dextrose, TPN or other similar solutions is not covered under warranty.*

### **5.1.2 Pump IV Sets and Syringes**

***The condition of the IV set or syringe you install in the device under test will largely determine the quality, validity and accuracy of your test results.***

You should obtain a *new IV set* for each make of pump you will be testing. Use the IV set only with distilled water or clean tap water. After testing the pump, drain the IV set and store it in an air-tight bag or container until another pump of the same type needs testing. ***Do not store the set in a pump or use the set's roller clamp or pinch clamps to keep the set primed.*** Doing so will quickly degrade the IV set and will likely influence the set's accuracy.

"Test IV sets" may remain usable up to several weeks if you treat them carefully as described above. However, *accuracy* of IV sets is usually not guaranteed by the manufacturer over such long intervals. Ideally, IV sets should be replaced in accordance with manufacturer's recommendations (e.g. every 48 hours of testing) so that test results reflect clinical usage of the infusion device.

***Always install a new disposable syringe before testing a syringe pump.*** The lubrication in disposable syringes tends to wear off after a few uses, causing the syringe plunger to stick in the barrel. A syringe pump equipped with an old, worn-out syringe will deliver erratically and inaccurately, and this will be evident as "spikes" appearing on Infutest's flow graph display.

## INFUTEST 2000E OPERATING MANUAL

If somebody gives you a pump to test, and that pump has a used set or syringe in it, take the set out of the pump and ***throw it away***. A set which has been used on a patient may contain saline, dextrose or other solutions which may potentially damage the Infutest.

If you ***must*** re-use an IV set for an incident investigation, first rinse the IV set with distilled water and flush the Infutest thoroughly after the tests have been completed.

### **5.1.3 Cleaning**

***NOTE: The cleaning procedure for the Infutest Series E is different from previous series of Infutest. Improper cleaning of the unit may result in damage which is not covered under warranty.***

The following cleaning procedure should be performed on the Infutest once per month if the instrument is used with tap water, or once every three months if the Infutest is used exclusively with distilled water. These recommendations apply to instruments which remain set up and primed at all times. If the Infutest spends most of its time dry and in storage, cleaning should be conducted more frequently, ideally when the dry instrument is first primed during setup. Cleaning after a period of dry storage is the preferred method of "wetting" the fluid system prior to use (see Section 3.2, *Priming*).

In the event of accidental contamination with dextrose or TPN solution, the following procedure should be adequate provided cleaning is performed immediately following contamination. If cleaning does not appear to improve test results (i.e. flow measurements are persistently erratic, low or nonexistent), contact your dealer and/or Datrend Customer Service.

- a. Make up about 200 ml of cleaning solution by mixing 100 ml of distilled water with 100 ml of "Sudsy Ammonia" household cleaner (e.g. AMEX brand by Colgate-Palmolive Inc.). If "Sudsy Ammonia" is not available in your area, add one-half teaspoon of liquid dish detergent to the 200 ml of ammonia and water solution.
- b. Fill a disposable 60 ml syringe with the cleaning solution and discharge the syringe quickly into CHANNEL A at about 2 ml per second. Don't use the same syringe you use to prime the Infutest because the cleaning solution will remove the syringe's lubricant. Refill the syringe and inject CHANNEL B with the cleaning solution in the same manner.

## INFUTEST 2000E OPERATING MANUAL

- c. Fill the syringe with 20 ml of cleaning solution and connect the syringe to CHANNEL A. Inject about 10 ml into the channel. **Under no circumstances should you quickly draw solution back into the syringe as the excessive suction may damage the pressure sensors.**
- d. Repeat (c) for CHANNEL B.
- e. Let the cleaning solution sit in the Infutest for about 10 to 15 minutes. **DO NOT** leave the cleaning solution in the Infutest any longer than 15 minutes as prolonged exposure to the solution may damage the neoprene seals of the internal valves.
- f. Rinse the fluid channel thoroughly with distilled water to remove all ammonia from the fluid system.
- g. If the fluid system has been contaminated with a sticky liquid (e.g. D5W, D25W, TPN solution, etc.), you may need to perform this procedure using undiluted Sudsy Ammonia to clean the flow sensors. In this case, **DO NOT** leave ammonia in the Infutest for more than 10 minutes, and be sure to thoroughly flush the instrument with distilled water afterwards.

### **5.1.4 Input and Output Connections**

The input tubing sets supplied with your Infutest incorporate a calibrated flow restriction so as to be in conformance with IEC recommendations, simulating viscous fluids (IEC 601-2-24 Pt. 2). ***Always connect the device under test (DUT) to the flow restriction, not the prime/flush port of the input stopcock (see Figure 4).*** Do not attempt to bypass or remove the flow restriction. Accuracy of the Infutest is specified only with the IEC flow restriction in line.

***When using only one Infutest channel to test a single infusion device, do not leave the unused channel's input open to air.*** Ensure that the stopcock of the unused channel is rotated to the CHANNEL OFF position to block off the unused input (see **Figure 6**). If the unused input is not blocked, Infutest's internal fluid system will fill up and will eventually drain out the open input. Although this will cause no damage to the Infutest, the resulting drainage may adversely affect nearby electronic equipment.

*Do not extend the length of the supplied A&B Output tubing set by more than 12" (30 cm).* Do not restrict the output tubing set or extend it with narrow-gauge IV tubing. Follow the instructions in Appendix A when applying a back pressure to the A&B Output.

*Do not attempt to verify calibration of the Infutest by connecting the A&B Output to a burette or other volumetric or gravimetric measuring device.* The output of Infutest's two flow channels are combined in an internal reservoir or "collection tank" before draining via the A&B Output port (see Appendix B, *Operational Overview*). The tank is filled mostly with *air* when the pressure applied to the A&B Output is near zero. Therefore, the flow of test fluid into the Infutest and the exit of test fluid from the A&B Output are poorly related except in a gross sense.

*You should ensure no fluid pressure is applied to the Infutest's inputs or output when you first turn the instrument on.* This is important because Infutest attempts to zero the offset of its pressure transducers as part of an internal self-test.

Remember if you allow gravity free-flow through a pump from an IV bag to the Infutest, you will be applying a pressure to the Infutest by virtue of the head created by elevation of the IV bag. *Install the set into the pump to stop the free-flow and eliminate the pressure head before turning on the power to the Infutest.* Otherwise, Infutest may display a "pressure zero alarm" at the end of its self-test (see Section 3.2, *Priming*).

### **5.1.5 Flushing Prior to Test Startup**

***Before starting a Single Rate Test (or any AutoSequence incorporating a Single Rate Test), the channels should be flushed to purge extraneous air bubbles from the channel's flow sensor. This is always the safest way to avoid potential problems.***

Do not forcefully inject large volumes of water into the channel when flushing. *Such action will generate troublesome air bubbles rather than purge them.* To minimize bubbles generated by turbulence, gradually inject about 5cc from the priming syringe over a few seconds.

## INFUTEST 2000E OPERATING MANUAL

You may also use the device under test (DUT) to purge the fluid channel if you wish. If the DUT is pumping at **100 ml/hr** prior to test startup, it will take the DUT at least **90 seconds** to infuse the minimum amount required for purging. If the DUT is set to a lower rate, a proportionally longer time must be allowed.

In the process of measuring flow and volume, Infutest deliberately introduces air bubbles into the test fluid as flow "markers" (see Appendix B, *Operational Overview*). If air bubbles are present in the channel *before* a Single Rate Test is started, such extraneous bubbles may cause the flow and volume displayed to be **multiplied by a factor of two or more**. If, for example, you are testing a pump set to 400 ml/hr and Infutest consistently reads around 800 ml/hr or higher, the error may be because the fluid channel was not flushed before the Single Rate Test was started. This is the primary risk of not flushing the channel before test startup. If the device under test is known to produce *continuous flow*, and the device is being tested at rates *below 170 ml/hr*, this multiplication error may not occur and so flushing prior to starting the Single Rate Test is optional.

The Infutest incorporates software algorithms to **reject** most air bubbles in the test fluid which arise from outgassing, and which may accidentally drift into the fluid channel while running a test. The Infutest will also reject some air bubbles in the fluid channel which it detects at test startup.

Infutest's "bubble rejection software" is highly effective in the Dual-Rate and PCA Pump Tests, which operate over a restricted range of flow rates (up to 170 ml/hr). Flushing the fluid channel prior to starting a Dual-Rate, PCA Pump or Occlusion Pressure Test is rarely necessary, unless the channel is completely dry.

However, the bubble rejection software of the Infutest is somewhat less effective in the Single Rate Test than the other tests due to the extended range of flows which may be measured (up to 999 ml/hr). It is *always* best to flush the channel before running a Single Rate Test.

## 5.2 Single Rate Test

### 5.2.1 Test Description

*The Single Rate Test is the test you will select in most cases to verify flow and volumetric accuracy on all types of infusion devices - ranging from acute care to home care pumps, and including syringe pumps, linear peristaltic pumps, cassette pumps, ambulatory pumps, and enteral feeding and TPN/TNA pumps.*

The Single Rate Test measures flow over two ranges - LOW and HIGH. The LOW range is used for measuring flow below 170 ml/hr, and the HIGH range above 170 ml/hr, up to 999 ml/hr. Transparent to the user, the Infutest selects the most appropriate flow range automatically at the beginning of the Single Rate Test through execution of both *range selection* and *flow pattern recognition* software algorithms.

These algorithms will select the HIGH range if pulsatile or erratic flow is detected at the start of the test. For pulsatile flow patterns, a greater degree of volumetric averaging is applied to increase the accuracy of the flow measurement, however, measurement time may be substantially increased. For pulsatile flow with an average rate of 5 ml/hr, a single measurement will require nearly 14 minutes to complete, as opposed to a nominal 11 seconds for 5 ml/hr continuous flow. The type of flow detected will be displayed in the flow status indicator, which appears in the upper right hand corner of the test measurement screen. The flow status indicator may show **LOW** or **HI** if the flow pattern is relatively smooth and continuous, **PUL** if moderately pulsatile flow is detected (pulses having volume 0.035 to 0.070 ml - typical of Abbott Lifecare 4P and similar pumps), or **VPF** if very pulsatile flow is detected (pulses having volume over 0.070 ml - typical of enteral feeding ("Kangaroo") pumps).

Infutest will always assume **LOW** flow at the start of the test, and will, if necessary, make a change *after 0.2 to 1.2 ml* has been delivered. In some instances, the flow status indicator may intermittently read **IFL** ("interrupted flow") when running a LOW flow test. This is an indication that the pump under test has generally continuous flow, with intermittent pauses in flow. This is typical of some linear peristaltic pumps which have a pause in their flow pattern when the pump mechanism reaches the bottom of its travel and recycles to the top (e.g. Baxter FloGard 6201, Sigma 6000).

## INFUTEST 2000E OPERATING MANUAL

The Single Rate Test also incorporates a software algorithm called *SynchroStart*. When you start the Single Rate Test, SynchroStart places Infutest on "standby" until fluid flow is actually detected from the device under test (DUT). As flow from the DUT is detected, SynchroStart automatically initializes the flow and volume measurements. In an AutoSequence, SynchroStart also prevents the **INF** **TIMER** ("infusion timer") from running until flow from the DUT is detected. *Synchronizing* the startup of the Single Rate Test to the flow produced by the DUT is important for accurately measuring the cyclic fluid delivery produced by pulsatile infusion devices, and also for measuring the actual volume delivered by a DUT in a preset *VTBI* ("Volume-to-Be-Infused") or "*DOSE*".

The table below lists nominal times required for the Infutest to obtain measurements at selected flow rates. The theoretical values listed are approximate and assume continuous flow conditions.

FLOW RATE (ml/hr)	MEASUREMENT TIME
0.1	15 to 20 minutes, first measurement, 10 minutes, subsequent measurements
1	1.5 to 2 minutes, first measurement 1 minute, subsequent measurements
6 to 170	10 to 15 seconds
Switch to HIGH range above 170 ml/hr...	
200	20 seconds
500	10 seconds
999	4 seconds



### 5.2.2 Test Usage

The most basic use of the Single Rate Test is to verify rate accuracy of an infusion device. To verify rate accuracy, program the device with the desired test Rate and disable the "**Volume-to-Be-Infused**" (VTBI) or "**Dose Limit**" function on the device. Alternatively, you may set the VTBI or Dose on the device under test (DUT) to an arbitrarily large value (e.g. 9999 ml). Connect the DUT to Infutest, flush the channel, start the test on the Infutest (press GO) and then run the DUT. The length of time you choose to run the Single Rate Test will depend on the type of pump you are testing (see Section 5.7, *Understanding Your Test Results*). Refer to the manufacturer's recommendations with respect to volumetric accuracy testing, which should be included in the manufacturer's Service Manual for the DUT.

If the DUT produces *continuous flow* (e.g. syringe pump), you may start the Single Rate Test either before or after starting the DUT if you are simply checking for basic rate accuracy. If the DUT is *pulsatile*, and especially if the DUT is used in *enteral feeding or TPN applications* (e.g. "Kangaroo pump"), you should start the Infutest *first*, and *then* start the DUT running after Infutest switches from the START to TEST display. This will activate Infutest's **SynchroStart** feature so that the Single Rate Test is synchronized with the delivery cycle of the DUT.

Flow pattern recognition is ongoing throughout the Single Rate Test. At the start of the test, the flow pattern recognition may select **PUL** or **VPF** measurement algorithms based on a startup surge or other flow anomaly that the DUT produces when it first starts running. If you wish to avoid this, start the Single Rate Test *after* letting the DUT run and stabilize for a few minutes.

In addition to rate accuracy testing, you may also use the Single Rate Test to verify accuracy of the DUT in delivering a preset Volume-to-Be-Infused (**VTBI**) or **Dose**.

Program the DUT with the desired Rate and VTBI/Dose. Suitable Rate and VTBI settings for this type of test will usually appear in the Service Manual of the DUT, under a "flow accuracy" or volumetric test procedure. Prior to starting the test, *clear* or reset the **Total Volume Infused** on the DUT. Most infusion devices provide a separate button for clearing the Total Volume Infused.

## INFUTEST 2000E OPERATING MANUAL

When testing a pump for VTBI or Dose delivery accuracy, Infutest should *always* be started *first*, and the DUT started *afterwards*. If the DUT is started *before* the Single Rate Test, you will defeat Infutest's SynchroStart feature and the infused volume as measured by Infutest *may be erroneously LOW*. If the test is not SynchroStarted, it is likely that the volume dispensed from the DUT at the beginning of the infusion will be missed.

The DUT will typically produce an audio-visual alarm (the "End-Of-Infusion" alarm) when it completes delivery of the VTBI or Dose. Infutest's **STOP** key should be depressed the instant this alarm is produced to obtain an accurate measure of the actual volume delivered by the DUT. Pressing the **STOP** key will activate Infutest's *End-Infusion-Analysis (EIA)* feature. EIA calculates the total volume infused by the DUT using the measured Average Flow and the elapsed time at which the test was **STOP**ped. *The EIA will be accurate provided the pump is running or just coming to a stop at the time the STOP key is pressed.*

If the STOP key is depressed substantially *after* the DUT ends the VTBI delivery, you will introduce an error in the elapsed time of the test and the infused volume as displayed by Infutest *may be erroneously HIGH*. The "Volume Infused" displayed on Infutest's SUMMARY screen will flash to indicate this potential uncertainty in the End Infusion Analysis.

When testing a pump for VTBI or Dose delivery accuracy, *stopping* the test at the appropriate time is important to obtaining an accurate measure of the Volume Infused. Infutest's programmable *AutoSequences* provide an infusion timer (INF TIMER) which may reduce this uncertainty in a VTBI or Dose delivery test. Refer to the programming instructions in Section 4.10, *AutoSequences*.

## 5.3 Dual-Rate Test

### 5.3.1 Testing Piggyback Operation

*"Piggybacking" is the clinical term most often used to describe delivery of a "Secondary" Volume-to-Be-Infused (VTBI) or Dose at a first rate, followed by delivery of a "Primary" VTBI or Dose at a second and often lower flow rate. Use the Dual-Rate Test to evaluate Primary-Secondary delivery or delivery "piggybacking" on continuous-flow infusion devices which provide this feature.*

Restrictions which apply to the Dual-Rate Test are:

- i. continuous flow conditions only (non-pulsatile)
- ii. maximum flow rate is 170 ml/hr average, 200 ml/hr peak
- iii. **at least 1.0 ml** of fluid must be delivered at the Secondary rate (Infutest RATE #1)
- iv. **to detect the switch from Secondary delivery to Primary delivery, the Secondary flow rate setting on the pump must be at least five times higher than the Primary rate setting.**

For example, an infusion device capable of piggyback operation might be programmed with the delivery schedule listed below, and the actual delivered volumes and rates could be verified using the Dual-Rate Test. In a "piggybacked" infusion, the Secondary medication is delivered first. Infutest will display the Secondary delivery as RATE #1 and the Primary delivery as RATE #2.

Delivery	Flow Rate Setting	VTBI or "Dose"	Infusion Time
Secondary (RATE #1)	100 ml/hr	5.0 ml	3.0 min
Primary (RATE #2)	20 ml/hr	2.0 ml	6.0 min

Once the above rates and volumes have been programmed into the device under test (DUT), the **Total Volume Infused** on the DUT must be **cleared** or reset before starting the test. Most infusion devices provide a separate button for clearing the Total Volume Infused.

In a "Piggyback" test, Infutest should *always* be started *first*, and the DUT started *afterwards*. If the DUT is started *before* the Dual-Rate Test, you will defeat Infutest's SynchroStart feature and the Secondary volume as measured by Infutest *may be erroneously LOW* (see Section 5.2.2, *Test Usage Single Rate*).

The DUT will typically produce an audio-visual alarm (the "End-Of-Infusion" alarm) when it completes delivery of the Primary VTBI or Dose. Infutest's **STOP** key should be depressed the instant this alarm is produced to obtain an accurate measure of the Primary volume delivered by the DUT. If the STOP key is depressed *after* the DUT produces the alarm, you will disrupt Infutest's End-Infusion-Analysis feature and the Primary volume as measured by Infutest *may be erroneously HIGH* (see Section 5.2.2, *Test Usage Single Rate*). The "Volume Infused" displayed on Infutest's SUMMARY screen will flash to indicate this uncertainty in the End Infusion Analysis.

Some DUT's produce a brief audio-visual indication at the end of the *Secondary* delivery. Do not confuse this indication with the DUT's End-Of-Infusion alarm. Audio tones produced at the conclusion of the Secondary delivery are usually not persistent, whereas an End-Of-Infusion alarm will persist until the "ALARM SILENCE" or equivalent button on the DUT is pressed.

Stopping the Dual-Rate Test at the appropriate time is important to obtaining an accurate measure of the Primary infused volume. Infutest's programmable *AutoSequences* provide an infusion timer (INF TIMER) which may reduce uncertainty in the timing aspect of the Dual-Rate Test. Refer to the programming instructions in Section 4.10, *AutoSequences*. Note that for a Dual-Rate Test you will program the INF TIMER based on the expected durations of the Secondary delivery *plus* the Primary delivery, as follows:

$$\text{INF TIMER} = \left( \frac{\text{Secondary VTBI (ml)}}{\text{Secondary Rate (ml/h)}} * 3600 \right) + \left( \frac{\text{Primary VTBI (ml)}}{\text{Primary Rate (ml/h)}} * 3600 \right)$$

### **5.3.2 Testing Titrated Rates**

Some infusion devices, although unable to switch flow rate automatically, allow the user to change the rate while the device is pumping. This feature is sometimes referred to as *titration*. Provided the flow rate can be reduced quickly enough, the Dual-Rate Test may be used to evaluate a titratable infusion device at two different rates without stopping the test. Although using the Dual-Rate Test may be quicker than conducting two Single Rate Tests in succession, the restrictions described in the previous section must be observed.

### 5.3.3 Testing KVO Operation

Most infusion devices incorporate a *Keep-Vein-Open* (KVO) function. Such pumps will automatically switch to the *KVO Rate* after delivery of a preset Volume-to-Be-Infused (*VTBI*) or *Dose*. The KVO Rate depends on the make and model of the infusion device being tested, although most pumps have a preset KVO Rate in the range 1 to 5 ml/hr. Some infusion devices (e.g. MedFusion 2001) allow the KVO Rate to be programmed over a restricted range.

The Dual-Rate Test may be used to check the KVO function of an infusion device even though the device may not be capable of "piggybacked" deliveries. In accordance with the Dual-Rate Test restrictions, ensure the primary delivery rate is at least five times the KVO Rate of the pump for the switch to KVO operation to be detected.

For example, you could program an infusion device with the following rate schedule and check the device's switch to KVO mode using the Dual-Rate Test. Infutest will indicate the KVO delivery as RATE #2.

Delivery	Flow Rate	VTBI or Infusion "Dose"	Time
RATE #1	50 ml/hr	5.0 ml	6.0 min
KVO (RATE #2)	5 ml/hr	N/A	As desired

Remember to start the Dual-Rate Test *first*, and *then* the infusion device so that the actual volume infused at RATE #1 is measured accurately. After the infusion device switches to KVO operation, allow the test to continue for at least few minutes so that an accurate measure of the average KVO Rate is obtained. (The DUT's KVO alarm indicator will usually continue to sound and must be ignored for the duration of the KVO rate measurement).

### 5.3.4 Testing Bolus-Plus-Basal Mode Operation

Some Patient-Controlled Analgesia (PCA) pumps are capable of infusing a preset *Bolus* volume while simultaneously delivering medication at a background *Basal* flow rate. The Dual-Rate Test may be used to evaluate this feature. Refer to the PCA pump manufacturer's manuals regarding Basal delivery.

Set the *Basal Rate* equal to or less than one-fifth the Bolus delivery rate of the PCA pump. If the Bolus delivery rate of the pump is unknown, try a Basal Rate of 10 ml/hr. Program the pump to deliver a suitable *Bolus Volume* (e.g. 2 ml) and start the device pumping at the Basal rate.

Set up the Infutest for a Dual-Rate Test. Start the Dual-Rate Test, then *at the same time* trigger the PCA Pump manually with the patient's medication delivery switch. After Bolus delivery, leave the pump running at the Basal rate for a few minutes. The Dual-Rate Test will measure the volume of the Bolus delivered, the rate at which it was delivered (RATE #1), and the background Basal flow rate (RATE #2).

### **5.3.5 Dual-Rate "PULSATILE" Warning**

*The Dual-Rate Test is suitable for use only with continuous-flow infusion devices.* If Infutest detects that the infusion device produces pulsatile flow, a **WARNING!** message will be displayed on the test measurement screen and the flow status indicator will flash "**PUL**". In this case, changes in flow rate will not be detected and Infutest will remain measuring RATE #1 indefinitely. *Flow and volume measurements displayed on screen may also be erroneously LOW if the pulsatile warning message is posted during the Dual-Rate Test.*

Pulsatile infusion devices should be evaluated using the Single Rate Test (see Section 5.2).

## 5.4 PCA Pump Test

### 5.4.1 Test Description

*Use the PCA Pump Test to determine volumetric accuracy and verify lockout operation of continuous-flow, patient-controlled infusion devices. The volume of each Bolus delivered is precisely measured using the LOW range of the flow sensor, and lockout time is determined to the nearest second, based on observation of flow onset and cessation.*

Restrictions which apply to the PCA Pump Test are:

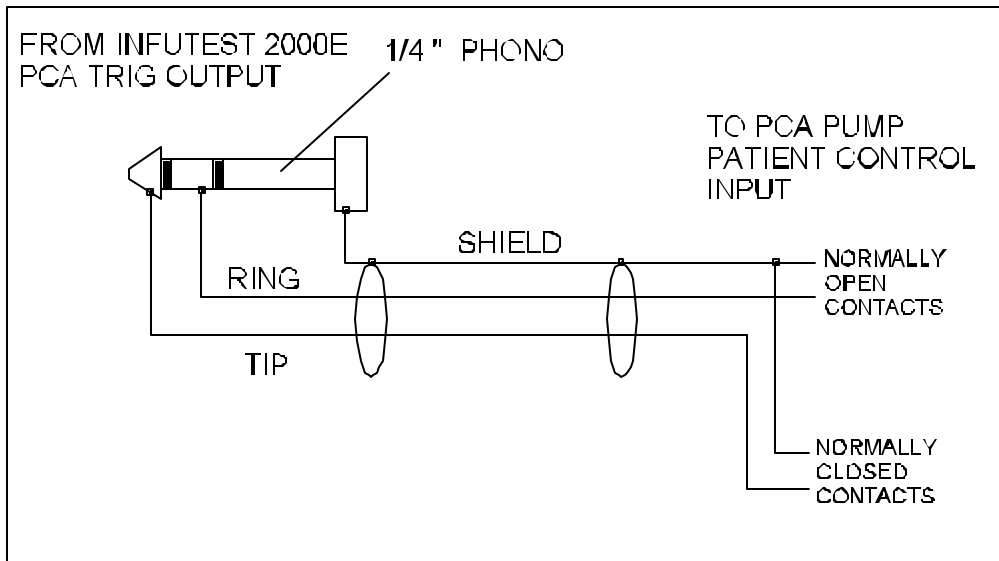
- i. continuous flow conditions only (non-pulsatile)
- ii. maximum flow rate is 170 ml/hr average, 200 ml/hr peak
- iii. bolus volume must be at least **0.5 ml**
- iv. **flow must be zero during the lockout period**

The PCA Pump Test requires a cable to connect a trigger output on the Infutest rear panel (*Figure 3*) to the patient control switch input on the PCA pump. A pair of unterminated cables with two insulated conductors plus braided shield is available as an accessory from Datrend Systems (PCA-1). A schematic of the unterminated cable is shown in *Figure 29*.

The Infutest PCA trigger incorporates both normally-open or normally-closed relay contacts which are activated during the PCA Pump Test to simulate the patient actuating the medication delivery switch. Connection of the Infutest to the PCA Pump is dependent on the make and model of the pump; refer to the manufacturer's technical service manual when preparing a PCA trigger cable.

When the PCA Pump Test is started, the Infutest will activate the trigger relay until flow from the pump is detected. Flow and cumulative volume measurements are obtained until the programmed bolus is delivered and flow falls to zero. The Infutest detects this condition and begins to time the lockout period, simultaneously attempting to trigger the pump to deliver another bolus via its internal trigger relay.

During the lockout period, a timer posted in the upper right corner of the test measurement screen keeps track of the elapsed time of the lockout. When flow is detected, the trigger relay is stopped and the delivery/lockout measurement process is repeated. The number of boluses delivered, the average bolus volume, average lockout time and average bolus flow rate is provided in the channel Summary. Full details of each bolus delivered is available in the channel Data Log.



*Figure 29 - Schematic of unterminated PCA trigger cable (PCA-1), available from Datrend Systems. The trigger output is provided by floating relay contacts; normally-open contacts are available between ring and shield; normally-closed contacts are available between tip and shield.*

### 5.4.2 Test Usage

Connect the trigger cable to the trigger output of the Infutest, and select the PCA Pump Test via the START screen. Program the pump to deliver several boluses; the test algorithm works well with bolus volumes of approximately 1.0 to 2.5 ml. Programming the lockout time to the minimum setting available on the pump (typically 1 to 5 minutes) will shorten total testing time while providing adequate verification of lockout operation. If the bolus delivery rate is also programmable, set it between 25 and 100 ml/hr.

*If the PCA pump is capable of producing a "Basal Flow", ensure the Basal rate is set to zero or that Basal delivery is disabled. To test Bolus-Plus-Basal mode delivery, use the Dual-Rate Test as described in Section 5.3.4.*



## INFUTEST 2000E OPERATING MANUAL

Some PCA Pumps do not provide an electrical trigger input suitable for connection to Infutest's PCA trigger output. Ambulatory PCA Pumps may have only a front panel push button which is pressed to deliver a bolus. Other PCA Pumps may have a pneumatically-based trigger switch. Such PCA pumps may be tested *manually*, using the real-time display of the lockout posted on the test measurement screen as a "prompt".

For manual PCA Pump testing, the lockout interval of the pump is presumed to be preset to an integer number of minutes (e.g. 5.0 minutes). During the lockout period, Infutest will produce an audio alert tone every time the *seconds indicator* of the lockout time display passes **45 seconds**. The audio alert is meant to signal the user to manually activate the trigger button on the PCA pump as the end of the preset lockout approaches. The PCA Pump should be repeatedly triggered about once per second after Infutest produces an alert tone which is close to the preset lockout time, until the pump actually begins to deliver a bolus. At the start of a bolus delivery, the Infutest trigger relay will stop and the state of the test measurement screen will change.

### **5.4.3 PCA Pump "PULSATILE" Warning**

*The PCA Pump Test is suitable for use only with continuous-flow infusion devices.* If Infutest detects that the infusion device produces pulsatile flow, a **WARNING!** message will be displayed on the test measurement screen and the flow status indicator will flash "**PUL**". The PCA Pump Test will still detect bolus deliveries and lockout intervals even if the **WARNING!** message is activated. *However, flow and volume measurements displayed on screen may be erroneously LOW.*

## 5.5 Occlusion Pressure Test

### 5.5.1 Measuring Occlusion Pressure

*Use the Occlusion Pressure Test to determine the maximum pressure generated by an infusion device when its output is occluded.*

Set the infusion device to produce a suitable flow rate (e.g. 50 to 100 ml/hr) and start the device pumping. Starting the Occlusion Pressure Test will cause the channel to be occluded by an internal valve, and the pressure at the input to be sampled and displayed once every two seconds.

If the infusion device is operating properly, the displayed pressure will increase until the device detects the occlusion, stops pumping, and produces an alarm. After this point, the displayed pressure will remain approximately constant or may decrease slightly. The pressure at which the device produces the alarm is the occlusion pressure. If the test is terminated by the test timer or terminated with the STOP key, the Summary will report the maximum pressure reading from the test. If the Nurse Call is activated during the occlusion pressure test, the Summary will report the pressure reading when the Nurse Call signal occurred. This will normally coincide with the pump's occlusion alarm.

If the measured pressure exceeds 2586 mmHg (50psi) during the test, the internal occluding valve will be automatically opened, the test will be stopped, and the Summary will indicate an Over Pressure Reading.

It is important to note that most pumps sample their internal pressure signal at a relatively slow rate. *If the pump is tested at too high a rate, it is quite likely that the actual occlusion pressure will be higher than the maximum specified by the manufacturer.* In many cases, Infutest will measure and report the *actual* pressure, which may seem high. If this occurs, rerun the test at a lower rate (try 50 ml/hr) and see if the occlusion pressure seems more reasonable.

### 5.5.2 Checking the Nurse Call Alarm

The Occlusion Pressure Test may also be used to check the operation of the Nurse Call Alarm output on an infusion device which incorporates this feature. The test requires a cable with two insulated conductors plus braided shield to connect the Nurse Call input on the Infutest rear panel (*Figure 3*) to the Nurse Call output of the infusion device. A pair of unterminated cables for this

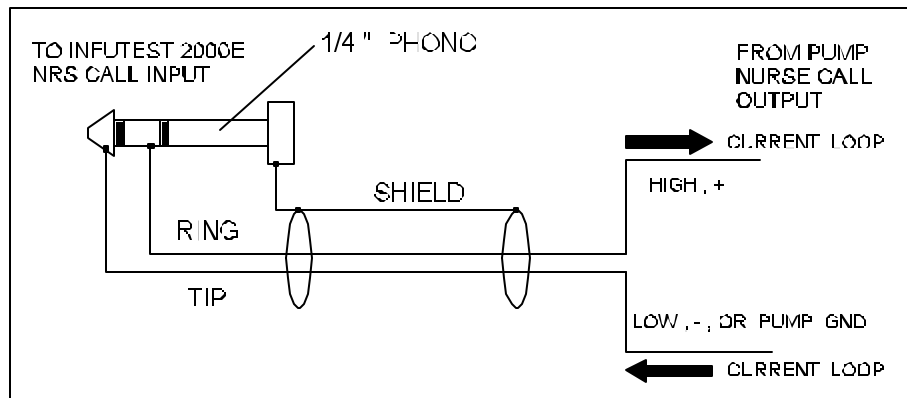
## INFUTEST 2000E OPERATING MANUAL

purpose is available as an accessory from Datrend Systems (NCA-1). A schematic of the unterminated cable is shown in *Figure 30*.

The Nurse Call Alarm produced by the infusion device may be any one of the following signals:

- i. normally-open or normally-closed relay contacts;
- ii. open collector output;
- iii. TTL output;
- iv. RS-232 level; or
- v. 20 mA current loop.

Refer to the manufacturer's technical service manual for the infusion device being tested when preparing a Nurse Call cable for connection with the Infutest.



*Figure 30* - Schematic of unterminated Nurse Call cable (NCA-1), available from Datrend Systems. For voltage-output Nurse Call, connect the higher potential to ring, and the lower potential or pump ground to tip. For current loop Nurse Call, connect so that current flows in direction of the arrows as shown above. For relay-output Nurse Call, the polarity of the connection is arbitrary. In all cases, the shield of the Nurse Call cable must not be connected to the pump.

During the Occlusion Pressure Test, the Nurse Call Alarm signal is sampled once every 200 msec and may be in either logical state at the start of the test. A **change** in the state of the Nurse Call signal will cause the pressure to be sampled immediately and stored in the Data Log with a "NRS CALL" message. The Occlusion Pressure Test is then automatically stopped. If the Occlusion Pressure Test is part of an AutoSequence, detection of a Nurse Call alarm will cause the AutoSequence to stop the occlusion test and begin the automatic report printout or download (if enabled).

## 5.6 AutoSequences

### 5.6.1 Running Default Test Sequences

Infutest is supplied to you with 9 automatic test sequences in battery-backed memory. These "AutoSequences" may be viewed, enabled and edited by powering up the instrument and pressing the EDIT SEQ key following the self-test.

The first six default AutoSequences are programmed as defined in the following table. The sequences include a timed Single Rate Test, with the duration of the test being set by the INF TIMER, followed by automatic output of the Test Summary Report to the printer.

TABLE I

Sequence Parameter	Factory Default Setting
ENABLED	NO
MFR, MOD, REMARK	Depends on pump make/model
RATE TEST	Single Rate
INF TIMER	Depends on manufacturer's test protocol
OCCL TEST	Off
AUTO-OUTPUT	Test Summary Report
OUTPUT TO	Printer port

Default AutoSequences 7, 8 and 9 are almost identical. ENABLED, RATE TEST, AUTO-OUTPUT and OUTPUT TO for these sequences are the same as shown above. For default AutoSequences 7, 8 and 9, INF TIMER is set to 180 sec and OCCL TEST is set to 1 min. MFR, MOD and REMARK are left blank.

The EDIT SEQ screen may be used to edit the above settings as desired. Refer to Section 4.10, *AutoSequences*. ***An AutoSequence must have "ENABLED" set to "Yes", otherwise the sequence cannot be selected via Infutest's START screen.***

## INFUTEST 2000E OPERATING MANUAL

The default INF TIMER settings are derived from Service Manual test protocols published by the manufacturers of Infutest's default infusion devices. These test protocols typically require the user to program the device under test (DUT) with a *RATE* and a "Volume-to-Be-Infused" (*VTBI*) or "*Dose*". Refer to the manufacturer's service manual of the DUT to review the relevant test procedure (usually referred to as a "flow accuracy" or volumetric test), setup of the DUT, and performance specifications or ranges of acceptance for device performance in these tests.

In accordance with the manufacturer's recommended test protocols, the Infutest's default infusion devices should be programmed as defined in the table below, prior to running the AutoSequence.

**TABLE II**

<b>AUTOSEQUENCE</b>	<b>MANUFACTURER AND MODEL NO.</b>	<b>FLOW RATE SETTING (ml/hr)</b>	<b>VTBI or "DOSE" SETTING (ml)</b>
#1	ABBOTT PLUM "XL" or PLUM 5000	400	10
#2	AVI/3M model 3000	999	49
#3	BAXTER FloGard model 6201	200	35
#4	IMED Gemini	125	5
#5	IVAC model 570	800	40
#6	McGAW Horizon	120	10

Before running a default AutoSequence, the device under test (DUT) should be set up, primed, and connected to Infutest. A printer should be connected to Infutest's printer port and should be ON LINE prior to starting the sequence. Default AutoSequences automatically output the Test Summary Report, which consists of a single printed page.

If the OUTPUT TO port of a default AutoSequence is changed to "Serial", the Infutest should be connected to a COM port on the receiving device (i.e. the PC) prior to starting the sequence. The PC should be running a *terminal emulation program* (e.g. Windows Hyperterminal, or Datrend's DTP software) which will save the down loaded test report to disk when the report is transmitted from Infutest at the end of the AutoSequence. Refer to **Section 3.3** for the necessary interface connections.

Verify the Rate and VTBI/dose settings for the DUT are programmed as defined in TABLE II. Before running the DUT, clear the DUT's "**Total Volume Infused**" display. Most infusion devices provide a separate button on the front panel which will reset the Total Volume Infused.

Flush the Infutest. Start the selected AutoSequence *first*, and *then* start the pump. This will activate Infutest's SynchroStart feature so the actual volume infused by the DUT is measured by the end of the rate test, which may then be compared to the acceptance range for delivered volume published in the manufacturer's Service Manual for the DUT.

### **5.6.2 Reloading Default Test Sequences**

If you make changes to the factory default AutoSequences and wish to restore the original settings, power up the Infutest while holding down the front panel key second from the left. Infutest will prompt you to reprogram the AutoSequences with factory default settings. *All 9 AutoSequences will be reprogrammed with factory defaults if you enter "YES".*

### **5.6.3 Adding the Occlusion Test to Sequences**

Most pumps sample their internal pressure signal at a relatively slow rate. If the Occlusion Pressure Test is run with the pump set at too high a rate, it is quite likely that the actual occlusion pressure will be higher than the maximum specified by the manufacturer. Because of this pump limitation, Occlusion Pressure Tests are best conducted with the pump rate set between *50 and 100 ml/hr* (see Section 5.5, *Occlusion Pressure Test*).

The manufacturer-specified test flow rates may be too high to conduct an Occlusion Pressure Test. However, the Occlusion Pressure Test may be added to the default AutoSequences if the pumps are programmed to decrease the flow rate at the onset of the pressure test. This may be accomplished by programming the pump with a "piggyback" delivery.

## INFUTEST 2000E OPERATING MANUAL

Follow these instructions to add an occlusion test to an AutoSequence, and then run the sequence:

- a. Run a manual Occlusion Pressure Test with the pump set to 50 ml/hr to determine the *nominal time* required for the device to produce an occlusion alarm. For the devices listed in the preceding table the required time is expected to be less than 2 minutes.
- b. Use the EDIT SEQ screen to program the desired AutoSequence with an appropriate OCCL TEST time, based on the findings of your experiment in step (a). Choices available for the OCCL TEST include 0.5 min; 1 min; 2 min; 3 min and so on. Refer to Section 4.10, *AutoSequences* for programming instructions.
- c. Leave RATE TEST set to "Single". Ensure that the desired AutoSequence has ENABLED set to "Yes". Exiting the AutoSequence screen will save the changes you made.
- d. Set up and prime the pump. Program the pump's *SECONDARY* RATE and VTBI or "Dose" with the settings listed in the previous table. Set the pump's PRIMARY RATE to **50 ml/hr** and VTBI or "Dose" to **100 ml**. Clear the "*Total Volume Infused*" display on the pump.
- e. On Infutest's START screen, select the desired AutoSequence. Flush the fluid channel and press the GO key.
- f. *After* starting the Infutest, start the *SECONDARY* infusion on the pump. At completion of the Secondary delivery, the pump rate should switch to 50 ml/hr and about two seconds later Infutest should begin the pressure test (the primary rate will not actually be tested, the switch is intended only to set the rate to a suitable value for occlusion pressure testing). Automatic report printout or download, if enabled, will follow the end of the timed pressure test.
- g. The next time you choose to run this AutoSequence, an occlusion test will be performed along with the timed rate test and automatic report output. Follow instructions (d) - (f) each time you run the sequence.

## 5.7 Understanding Your Test Results

Infutest measures Instantaneous Flow, Average Flow, and Infused Volume. *Of these, Average Flow and Infused Volume are the most important because it is these measures which the pump manufacturers use in specifying the accuracy of their products.* At this time, manufacturers do not specify pump performance in terms of instantaneous flow. However, Infutest's ability to measure instantaneous flow (and Infutest's FLOW graph display) may be useful in comparing the *quality* of fluid delivery of pumps of differing makes and models.

Infutest measures instantaneous flow by observing the volume delivered from a pump over relatively short time intervals. These time intervals nominally range from 4 to 20 seconds, the exact interval depending on the rate. *The majority of medical infusion devices do not produce "steady flow" when the volume delivered is measured over such short time intervals.* This fact has been previously described in the scientific literature. For example, refer to the test results and graphs in:

- Stull et al. "Flow rate variability from electronic infusion devices", *Crit. Care Medicine*, vol.16, pp. 888-891, 1988.
- Farrington "Flow rate variability from selected syringe and mobile infusion pumps", *Drug Intelligence and Clin. Pharm.*, Vol. 22, pp. 687-690, Sept. 1988.
- Leff et al. "Accuracy, continuity, and pattern of flow from five macrorate infusion devices", *Am. J. Hosp. Pharm.*, vol. 45, pp. 361-5, Feb. 1988.
- Auty, B. "Equipment for intravenous infusion - some aspects of performance", *Agressologie*, vol. 29, 12: 824-828, 1988.
- Tam, Y. "Automated performance checking of infusion equipment", *Clin. Phys. and Physiol. Meas.*, vol.10, pp. 311-318, 1989.

Infutest's Average Flow is a cumulative measurement of the total volume delivered from the pump divided by the total time taken to deliver it. All medical infusion devices will produce a stable Average Flow reading (i.e. a horizontal line on Infutest's AVG. graph) if given enough time. Infutest's instantaneous flow reading and FLOW graph, however, will be highly dependent on the *functional type, manufacturer* and *model* of pump being tested.



## INFUTEST 2000E OPERATING MANUAL

*Syringe pumps* (e.g. AutoSyringe AS20S, Bard 150 XL, MedFusion 2001) may exhibit a "startup characteristic" in which flow is initially low, and then gradually increases to the set rate as slack in the lead screw mechanism is taken up. Syringe pumps may also produce erratic flow if the syringe has been re-used so often that its internal lubricant has worn off. Such anomalies may be avoided, however, by installing a new syringe and allowing the pump to run for several minutes before testing.

*Linear peristaltic pumps* (e.g. Baxter 6200, Sigma 6000) tend to be more erratic in their instantaneous flow at lower rates - you will normally see large peaks and valleys in Infutest's FLOW graph when testing many linear peristaltic pumps at rates below 50 ml/hr. Such instantaneous variations are related to the design and precision of the finger mechanism which squeezes the tubing, and to the quality and compliance of the tubing section being squeezed.

The opposite is true of many *cassette pumps* (e.g. IMED 960, MAC MedSystem 3, McGaw Horizon, Siemens MiniMed III). These pumps often produce more erratic instantaneous flow at higher rates as the pump compensates between delivering the required volume and refilling its cassette on alternating cycles. Infutest's FLOW graph will normally show large peaks and valleys when testing many cassette pumps at rates over 500 ml/hr. Depending on the cassette pump, large dips in the FLOW graph may appear at periodic intervals.

Caution should be exercised when testing some cassette pumps. When set to high delivery rates, such pumps may produce brief bursts of flow which are beyond Infutest's ability to measure (peak flow exceeding 1700 ml/hr). In this case, Infutest will appear to "lock up", failing to begin a measurement or halting a measurement in progress. *For example, the IMED model 960 pump should not be tested at rates over 700 ml/hr.* If set to 800 ml/hr, the IMED 960 will produce a very high flow (exceeding 1800 ml/hr) immediately following the cassette refill cycle.

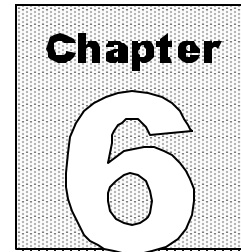
*Enteral feeding and TPN pumps* (e.g. Abbott Provider, Sherwood Kangaroo 324), inventoried by many *Home Care* providers, may produce the most non-steady flow of the devices mentioned so far. Such pumps often deliver fluid by alternately turning on and off the motor of a rotary peristaltic mechanism. Since the motor runs at one speed, the duration of the motor's "on-cycle" and the interval between on-cycles determines the flow rate. The bolus delivered in each on-cycle may range from 0.2 ml to 2 ml, with the zero-flow interval between bolus deliveries ranging from a few seconds to *several minutes*. Infutest's status indicator will show "VPF" when testing such devices, and the FLOW graph may show large, periodic rises and falls at rates over 100 ml/hr.

## INFUTEST 2000E OPERATING MANUAL

Because of these differences in short-term delivery characteristics, pump manufacturers choose to specify the accuracy of their products based on *Average Flow*, or the total volume delivered in a test divided by the total time. For most pumps operating at 50 to 500 ml/hr, Infutest's AVG. graph will stabilize to a straight, horizontal line after running the Single Rate Test for 5 to 10 minutes. At this point, most of the pumps described above will have produced a stable enough reading to verify the pump's accuracy. Note this limit on the minimum test time is due to the quality and design of the *pump being tested*, not the Infutest.

You should find a "flow accuracy" or volumetric test procedure in the Service Manuals of the infusion devices you will be testing. These procedures will define the manufacturers' recommendations for pump settings, minimum test time and/or collected volume. The pump Service Manuals will include specifications for device performance or an acceptance range based on the volumetric test results. Always refer to the manufacturer's procedures and recommendations before using Infutest to test your pumps.

**INFUTEST 2000E OPERATING MANUAL**



## Remote Control

*This chapter describes the Infutest serial communications features and explains the use of the commands used to request information from the Infutest, or to remotely control its operation.*

### 6. REMOTE CONTROL

#### 6.1 Overview

Infutest Remote Control (IRC) is the interactive software communications protocol command structure which allows Infutest to communicate with an external controller, such as a personal computer or other device, via RS-232. Using these communications protocols, Infutest may receive and respond to commands to start tests, stop tests, and transmit measurement data through the serial communications port.

IRC's comprehensive and flexible set of commands allows the creation of simple programs on a personal computer to automatically perform and document any pump test to any desired protocol. IRC is also compatible with other manufacturer's automated test instrumentation. However, not all IRC commands are compatible with all systems. Refer to the operator's manual for your instrument, especially with regard to serial port settings, serial cable wiring, data transmission format and data packet length.

This section of the manual describes the IRC commands and provides command examples.

## 6.2 Connections

- a. Connect Infutest's serial port to your controller's serial port using an RS-232 extension cable with a DB-25 female connector at the Infutest end. If your controller is a personal computer, use an RS-232 cable with a DB-25 or DB-9 female connector for the computer end and connect to COM1 or COM2 of the computer (an accessory RS-232 cable for use with the Infutest is available from Datrend Systems (SSC-1)).
- b. Each pin on the Infutest serial port connects to the *same* pin on your controller's serial port; do **NOT** use a null modem cable or null modem adapter. However, use of a commonly available RS-232 computer-to-modem cable with a gender changer is acceptable.
- c. Set the serial port on your controller as follows : **9600** baud, **NO** parity, **8** data bits, **1** stop bit
- d. *Refer to Section 3.3 for complete serial interfacing details.*

## 6.3 Command Syntax

All IRC commands follow the following, very simple format:

**COMMAND [ chan ] [ parameter ]**

where the COMMAND consists of two UPPER CASE letters, [chan] is the channel of interest (also UPPER CASE), and [parameter] is an additional numerical function parameter, if required. The complete command totals four (4) ASCII characters terminated by a carriage return (OD hex) and/or a line feed (OA hex). For the basic Infutest, the channel may be either A or B. If a Remote Sensor Module (RSM) has been connected, channel may also include C or D.

## **6.4 Command Types and Return Values**

*Test Control Commands* are used to start or stop tests and AutoSequences. If a Test Control command is received, Infutest will return one of the following:

- \* Acknowledged, test may be started/stopped
- ? Syntax error
- e Error, test already running on channel
- n Channel specified does not exist

*Report Output Control Commands* are used to put Summary or Data Logs for a completed test into the output queue. Infutest will return one of the following:

- \* Acknowledged, output job has been queued
- ? Syntax error
- n Channel specified does not exist

*Get Data Commands* are used to obtain specific data from Infutest's memory either during or after a test. If a Get Data Command is received, Infutest returns the requested data as a string of up to 34 ASCII characters, or one of the following error codes:

- ? Syntax error
- e Test/AutoSeq not stopped if summary data requested  
Test/AutoSeq not started if real-time data requested
- x No new data available if real-time data requested
- n Channel specified does not exist

All data returned from Infutest to the controller, including the error codes, are terminated with a carriage return (**CR**) character.

In some cases, Infutest will not transmit a response to a command. For example, Infutest may be busy sending measurement data to the controller and still receive additional commands from the controller. These commands will not be acknowledged, to prevent interference with the data transmission already in progress.

Infutest requires at least 50 milliseconds to interpret and begin executing a command once it has been received. You must ensure that your computer programs do not transmit commands to Infutest faster than one command every 50 milliseconds.

To prevent overloading Infutest with commands, it would be easiest to program your system to wait for a response from Infutest before proceeding to the next command.

## **6.5 Command List**

Test Control commands:

RT	Run Test
RS	Run Sequence
ST	Stop Test/Sequence

Report Output commands:

PR	Place Data to Print (parallel) in Output Queue
DL	Place Data to Download (serial) in Output Queue

Get Data commands:

GS	Get Test Summary Data (up to 34 characters)
GR	Get Real-time Data during test (up to 34 characters)

## **6.6 Command Descriptions**

This section presents the IRC commands, with detailed descriptions of each command. Examples of each command show exactly how the command should be typed, and the typical data Infutest would return to the controller.

### **6.6.1 Test Control Commands - RUN TEST**

Starts a test running on a channel.

Format:

```
RT[chan][parm]    chan =  A, B, C, or D
                   parm =  1 for single rate (SR)
                           2 for dual rate (DR)
                           3 for PCA
                           4 for occlusion (OP)
```

Examples:

```
RTA1 - run SR test on channel A
RTC3 - run PCA test on channel C (RSM only)
```

Returns:

```
*    Acknowledged, test may be started/stopped
?    Syntax error
e    Error, test already running on channel
n    Channel specified does not exist
```



### **6.6.2 Test Control Commands - RUN AUTOSEQUENCE**

Starts a preset AutoSequence running on a channel.

Format:

```
RS[chan][parm]    chan =  A, B, C, or D
                   parm =  1 for AutoSeq #1
                       2 for AutoSeq #2
                       Etc.
                       9 for AutoSeq #9
```

Examples:

```
RSA1 - run AutoSequence #1 on channel A
RSD5 - run AutoSequence #5 on channel D (RSM only)
```

Returns:

```
*    Acknowledged, test may be started
?    Syntax error
e    Error, test already running on channel
n    Channel specified does not exist
```

Note that the controlling device must be ready to receive serial data transfer of up to 60,000 characters if AutoSequence AUTO-OUTPUT is set to Summary or DataLog, and if OUTPUT TO is set to SERIAL.

### **6.6.3 Test Control Commands - STOP TEST/ABORT AUTOSEQUENCE**

Stops a running test or aborts an AutoSequence in progress on the specified channel.

Format:

```
ST[chan]          chan =  A, B, C, or D
```

Examples:

```
STA - stop test/AutoSequence on channel A
STC - stop test/AutoSequence on channel C (RSM Only)
```

Returns:

```
*    Acknowledged, test may be stopped
?    Syntax error
e    Error, no test currently running on channel
```

n Channel specified does not exist

#### **6.6.4 Report Output Control - PRINT REPORT**

Places a print job in the report output queue.

Format:

PR[chan][parm]      chan = A, B, C, or D  
                          parm = 1 for Summary Report  
                                      2 for Data Log Report

Examples:

PRA1 - put channel A Summary report in output queue  
          [print]  
PRD2 - put channel D Data Log in output queue  
          [print] (RSM only)

Returns:

\* Acknowledged, job placed in queue  
? Syntax error  
n Channel specified does not exist

#### **6.6.5 Report Output Control - DOWNLOAD REPORT**

Places a serial download job in the report output queue.

Format:

DL[chan][parm]      chan = A, B, C, D  
                          parm = 1 for Summary Report  
                                      2 for Data Log Report

Examples:

DLA1 - put channel A Summary report in output queue  
          [serial]  
DLD1 - put channel D Summary report in output queue  
          [serial] (RSM only)

Returns:

? Syntax error  
n Channel specified does not exist

Otherwise, Summary or Data Log report (up to 60,000 bytes)

### 6.6.6 Get Data Commands - GET TEST SUMMARY

Returns summarized test results as a string of up to 34 ASCII characters, terminated by a carriage return, after a test has been stopped or a preset AutoSequence has completed.

Format:

GS[chan][parm]      chan = A, B, C, or D  
                         parm = 1 for SR Summary  
                              or, for DR Summary RATE#1  
                              2 for DR Summary RATE#2  
                              3 for PCA Summary  
                              4 for OP Summary

Examples:

GSA1 - Get SR test Summary for channel A  
GSB3 - Get DR test Summary for RATE #2 from channel B  
GSD5 - Get OP test Summary from channel D (RSM only)

Returns:

For [parm] = 1 or 2

hh:mm:ss VVVV ml AAAAA ml/h

Where

hh:mm:ss      =      infusion time (hrs:min:sec)  
VVVV          =      infused volume  
AAAAA        =      average infusion rate

For [parm] = 3

VVVV ml AAAAA ml/h mm:ss  
or,  
VVVV ml ? AAAAA ml/h mm:ss?

Where

VVVV          =      average bolus volume  
AAAAA        =      average bolus delivery rate  
mm:ss        =      average lockout time between  
                 deliveries (min:sec)  
?              =      uncertainty indicator for  
                 volume or time  
                 (See Section 4.6.3)

For [parm] = 4

<type> PP.P psi pppp mmHg at mm:ss

Where

<type>	=	OVR for overpressure data
	=	MAX for maximum pressure data
	=	NRS for nurse call pressure data
PP.P	=	occlusion pressure, in psi
pppp	=	occlusion pressure, in mmHg
mm:ss	=	elapsed time to indicated pressure (min:sec)

**Error Codes Returned:**

?	Syntax error
e	Test/AutoSequence not stopped (Summary not available)
n	Channel specified does not exist

**6.6.7 Get Data Commands - GET REAL-TIME DATA**

Retrieves data in real-time as displayed on the LCD during test execution. Useful for logging data from extremely long pump tests or to run multiple tests, or to create Visual Basic/Visual C++ data acquisition programs. Data is returned as a comma delimited string of up to 34 ASCII characters, terminated by a carriage return. Data must be retrieved from the LCD before it changes, or that particular data is lost.

Format:

GR[chan]                    chan = A, B, C, or D

Examples:

GRA	-	Get displayed data from channel A
GRD	-	Get displayed data from channel D (RSM only)

Returns:

For SR, DR and PCA test data:

<type>, hh, mm, ss, FFFFF, AAAAA, VVVV, ppp

## INFUTEST 2000E OPERATING MANUAL

Where:

<type> = A - SR low range flow (LOW)  
B - SR high flow range (HI)  
C - SR pulsatile flow (PUL)  
D - SR very pulsatile flow (VPF)  
E - SR interrupted flow (IFL)  
F - DR rate #1 data  
G - DR rate #2 data  
H - PCA bolus flow data  
I - DR/PCA pulsatile warning data  
J - DR/PCA end of delivery data  
K - SR or DR end of infusion data  
L - PCA end of test averages

hh = Elapsed time, hours  
mm = Elapsed time, minutes  
ss = Elapsed time, seconds  
FFFFF = Instantaneous flow rate, ml/h  
AAAAA = Average flow rate, ml/h  
VVVVV = Effused volume, ml  
ppp = Back Pressure, mmHg

### Additional DR test data:

M = indicates start of rate #1  
N = indicates start of rate #2

### Additional PCA test data:

O, NNN = start of PCA bolus delivery #NNN  
Q, mm, ss = lockout time between bolus delivery  
NNN and NNN+1; mm = minutes, ss =  
seconds

### Occlusion Pressure test data:

R, mm, ss, PP. P, pppp

Where

R = occlusion pressure data indicator  
mm = elapsed time, minutes  
ss = elapsed time, seconds  
PP. P = pressure, psi  
pppp = pressure, mmHg

## INFUTEST 2000E OPERATING MANUAL

### End of Occlusion test data:

<type>, mm, ss, PP.P, pppp

Where

<type> = S for maximum pressure data  
= T for nurse call alarm data  
= U for overpressure data (exceeded 50 psi)

mm = elapsed time, minutes  
ss = elapsed time, seconds  
PP.P = pressure, psi  
pppp = pressure, mmHg

### Error Codes Returned:

x No new data available from LCD since last GR command received (No Data Ready)  
? Syntax error  
e Test/AutoSequence not running  
n Channel specified does not exist

## 6.7 Programming Examples


### 6.7.1 QBasic Programming

This section provides some examples of BASIC programs for controlling Infutest. MS-DOS<sup>1</sup> version 5.0 and 6.0 owners will be able to use Microsoft's QBasic<sup>1</sup> program.

The examples provided in this chapter were written for QBasic version 1.0<sup>2</sup> and assume some familiarity with BASIC or other programming languages. The examples include comments to explain what each program and each line does. Editing the programs to perform alternate tasks, or translation of the programs to Visual Basic or other compilable languages should be straightforward.

Assuming your PC is equipped with DOS 5 or a later version, power up your PC and then type:

**qbasic**

at the DOS command prompt. QBasic should boot, showing the "Welcome" screen. Press `ESC` to clear the screen, or press  to view the QBasic HELP index.

When typing in the programs, be sure to include all punctuation marks which appear in the programs. These punctuation marks ( " , ; ! % \$ and so on) are critical to proper functioning of the programs. However, you may delete the remark lines from the programs if you wish. In QBasic, remark lines begin with the quote character ( ' ).

Each program example must be typed in and then saved as a separate .BAS file. After you have finished entering one of the following example programs, save it by typing `SAVE`, followed by `FILENAME`. To run the example, connect Infutest to COM1, set up the pump and then type `LOAD` followed by `FILENAME`. To quit QBasic, type `QUIT` followed by `ENTER`. You can access QBasic's HELP system by typing `HELP`. If you need help on a QBasic keyword, move the cursor to the first letter of the keyword and then press F1.

---

1: The inclusion of this information with this manual should not be considered in any way to be an endorsement of a Microsoft product.

2: The INPUT statement of QBasic version 1.1 (supplied with MS-DOS version 6.0) may sometimes produce anomalous results on a high-speed computer when reading data from Infutest. No such problems have been detected with QBasic version 1.0, supplied as part of MS-DOS version 5.0.

*Example #1: Serial Connection Diagnostic*

```
' SPTST.BAS
' Serial Connection Test: Infutest-to-PC
' (c) Datrend Systems Inc. 2005
'
' This diagnostic tests the serial connection between Infutest and the
PC
' by sending a single character out COM1. If Infutest is powered and
' properly connected to the PC, Infutest should respond by sending back
a
' "?" character. If the response returned is not "?", 'ERROR' is
displayed
' on the PC screen. If there is a fault in the connection itself (e.g.
bad
' cable, wrong or defective COM port), the PC displays 'TIMEOUT'.
' The OPEN COM statement may be edited to set the port to COM2 if
desired.
' However, don't change any of the other parameters in the statement.
'
' This is a good program to try first.

Main:
CLS
PRINT "SERIAL CONNECTION TEST: INFUTEST-TO-PC"
PRINT
' Initialize COM1 for communication with Infutest.
OPEN "COM1: 9600, N, 8, 1, CD0, CS1000, DS0, OP0, RB2048, TB32" FOR RANDOM AS
#1
' Display TIMEOUT error message if no CTS on COM1 within 1 second
ON ERROR GOTO CommTimeOut
DO
' Read character from keyboard
DO
C$ = INKEY$
LOOP WHILE C$ = ""
' Send test character to Infutest via COM1
PRINT #1, C$
' Read response from Infutest via COM1. If response takes more
than
' 1 second, device timeout error is generated
INPUT #1, IFTdata$
' Expected response is "?"
IF IFTdata$ = "?" THEN
PRINT "O.K."
ELSE
PRINT "ERROR"
END IF
ReadKey:
LOOP UNTIL C$ = "x"
' Turn off COM port
CLOSE
END
CommTimeOut:
' Error interrupt handler.
' If no response from Infutest after 1 second, display timeout error
PRINT "TIMEOUT"
RESUME ReadKey
```



*Example #2: Single Rate With Occlusion Test*

```

' SROP_TST.BAS
' Single Rate Plus Occlusion Pressure Test
' (c) Datrend Systems Inc. 2005
'
' This QBasic program illustrates how to use the Infutest Remote Control
' commands to run a Single Rate Test followed by an Occlusion Pressure
' Test.
' After you input how long you want each test to run, the program starts
' the Single Rate Test, waits until the user-input time has elapsed, and
' then
' stops the test. The program then gets and displays the Single Rate
' test
' summary.
' An Occlusion Pressure Test is then started. After this test is
' stopped,
' the program gets and displays the peak pressure measured during the
' test.
' When both test results have been displayed, the program produces a
' "bee-bop" from the speaker to remind the tech that coffee is over!
' If you want to bypass either the Single Rate or Occlusion Pressure
' Tests,
' enter zero (0) for the test duration when prompted.
' If during either the Single Rate or Occlusion Pressure Test you want to
' skip the time remaining in the test, press the <ESC> key.
'
DECLARE SUB Delay (seconds%)
Main:
' Initialize COM1 for communication with Infutest.
OPEN "COM1: 9600, N, 8, 1, CD0, CS0, DS0, OP0, RB2048, TB32" FOR RANDOM AS #1
' Clear the PC's screen
CLS
' Display some reminders on the screen
PRINT "Flush Channel A and start device pumping."
PRINT
' Input testing times for Single Rate and Occlusion Pressure portions
' of the program.
INPUT "Enter duration of Single Rate Test (sec): ", SRtestTime%
INPUT "Enter duration of Occlusion Pressure Test (sec): ", OPtestTime%
' Conduct a Single Rate Test, if test time was not set to zero...
IF SRtestTime% <> 0 THEN
PRINT
PRINT "Executing Single Rate Test..."
PRINT #1, "RTA1"          ' Send START command to Infutest,
                        ' Chan A, SR Test
INPUT #1, IFTdata$      ' Get Infutest's "*" acknowledge response
Delay (SRtestTime%)    ' Delay the desired number of seconds
PRINT #1, "STA"        ' Send STOP command to Infutest
INPUT #1, IFTdata$     ' Get Infutest's "*" response

' Display the test results on the screen
PRINT : PRINT : PRINT "TEST RESULTS:"

PRINT #1, "GSA1"       ' GET Summary - up to 34 ASCII characters
INPUT #1, IFTdata$    ' Get and display data from Infutest

```

*Example #2: Single Rate With Occlusion Test (cont'd)*

```

PRINT " Time      Volume  Average Flow"
PRINT IFTdata$
PRINT
END IF
' Conduct an Occlusion Pressure Test, if test time was not set to
zero...
IF OPtestTime% <> 0 THEN
PRINT
PRINT "Executing Occlusion Pressure Test..."
PRINT #1, "RTA4"          ' Send START command to Infutest,
                          ' Chan A, OP Test
INPUT #1, IFTdata$       ' Get Infutest's "*" response
Delay (OPtestTime%)     ' Delay the desired number of seconds
PRINT #1, "STA"          ' Send STOP command to Infutest
INPUT #1, IFTdata$       ' Get Infutest's "*" response
' Display the test results on the screen
PRINT : PRINT : PRINT "TEST RESULTS:"
PRINT #1, "GSA4"         ' GET OCCL PR results command
INPUT #1, IFTdata$       ' Get data from Infutest and display
PRINT "      Occlusion pressure: "
PRINT IFTdata$
PRINT
END IF
' Output "I'm finished" sound
PLAY "03L8EC"
' Turn off the COM port
CLOSE
END
' Delay (seconds)
' This SUBroutine is called to produce a delay of 'seconds' allowing
Infutest
' some time to collect measurement data after a test has been started.
The
' time remaining in the delay is continuously posted on the screen.
' The time remaining can be skipped by pressing the ESC key on the
keyboard.
SUB Delay (seconds%)
row% = CSRLIN
PRINT "Time remaining in test: "; seconds%; "sec"
PRINT "Press <ESC> key to stop test"
DO WHILE seconds% > 0 AND INKEY$ <> CHR$(27)
' Wait here for 1.0 seconds
Tzero! = TIMER
DO WHILE TIMER - Tzero! < 1!: LOOP
' 1 second elapsed - decrement seconds counter
seconds% = seconds% - 1
' Update time posted on screen
LOCATE row%, 25
PRINT seconds%
LOOP
END SUB

```

*Example #3: Serial download from AutoSequence*

```
' AUTOSEQ.BAS
' AutoSequenced Test with Data Saved to File
' (c) Datrend Systems Inc. 2005
'
' This QBasic program illustrates how to use Remote Control commands to run
' an Infutest AutoSequence, and have the report automatically output by the
' AutoSequence saved in a disk file on your computer.
' The program first asks you to input a name for the file to save the data
' output at the end of the AutoSequence. The program starts AutoSequence #1
' running on Channel A after you input the file name, and then asks you to
' run the pump. AutoSequence #1 should be programmed with AUTO-OUTPUT
' set to "Summary" or "Log", and OUTPUT TO set to "Serial". You can set the
' other parameters of AutoSequence #1 to whatever you wish.
' The part of the program that does the downloading is fairly simple and
' can be easily transplanted to other programs which run just a Single
' Rate, Dual Rate etc test as opposed to a complete AutoSequence.
' AUTOSEQ.BAS relies on the fact that all test reports sent from Infutest
' via the serial port are terminated with the BELL character (CHR$(7)) as
' an end-of-file indicator. This tells AUTOSEQ.BAS that all the test data
' has been downloaded and the disk file can be closed.
' AUTOSEQ.BAS creates a new file for your test data, or overwrites existing
' files. If you want the test data appended onto a file which already
' exists in the current working directory, use 'APPEND' instead of 'OUTPUT'
' as the file mode in the OPEN statement for device #2.
'
Main:
' Initialize COM1 for communication with Infutest.
OPEN "COM1:9600,N,8,1,CD0,CS0,DS0,OP0,RB2048,TB32" FOR RANDOM AS #1
' Clear the PC's screen
CLS
' Display some reminders on the screen
PRINT "AUTOSEQUENCE DOWNLOADER"
PRINT
PRINT "Flush Infutest Channel A."
PRINT "Press any key to proceed or <ESC> to abort now: ";
' Wait here for user to press a key
DO
  C$ = INKEY$
LOOP WHILE C$ = ""
IF C$ <> CHR$(27) THEN
  PRINT
  INPUT "Enter file name for storage of test report: ", filename$
  PRINT
  PRINT #1, "RSA1"          ' Send START command to Infutest,
                          ' Chan A, AutoSequence #1
  INPUT #1, IFTdata$      ' Get Infutest's "*" response
  PRINT "AutoSequence #1 started."
  PRINT "Start infusion pump running anytime..."
```

*Example #3: Serial download from AutoSequence (cont'd)*

```
' ----- SERIAL DATA DOWNLOAD -----  
'  
' Open the file for the test report.  
' Substitute 'APPEND' for 'OUTPUT' if you want the data appended  
' to the end of an existing file.  
OPEN filename$ FOR OUTPUT AS #2  
  
' If you are not interested in AutoSequences, you can use a loop  
' like this to download test data collected during ordinary Single  
' Rate, Dual Rate, PCA Pump or Occlusion Pressure tests. Just  
' precede this DO loop by the statement PRINT #1, "DLA1" for the  
' summary, or PRINT #1, "DLA2" for the data log.  
DO  
  IFTdata$ = INPUT$(1, #1)           ' Wait here for a character  
                                     ' from Infutest  
  PRINT #2, IFTdata$;               ' Print character to file  
  
' Echo character to screen.  
' When printing to the screen, Qbasic translates "newline" to  
' "carriage return" and blanks the screen for "formfeed" characters.  
' This IF statement prevents this from happening.  
  IF IFTdata$ <> CHR$(10) AND IFTdata$ <> CHR$(12) THEN  
    PRINT IFTdata$;  
  END IF  
' Continue downloading until Infutest sends BELL character.  
LOOP UNTIL IFTdata$ = CHR$(7)  
PRINT  
' Output "I'm finished" sound  
PLAY "03L8EC"  
END IF  
' Close the data file and turn off COM port  
CLOSE  
END
```

*Example #4: Hard Disk Data Logger*

```
' LOGGER.BAS
' Log Infutest Data to Disk
' (c) Datrend Systems Inc. 2005
'
' Infutest's data log memory is limited to a maximum of 900 measurements
' per channel, or about 2 hours of testing at 100 ml/hr. This QBasic
' program shows you how to convert your PC into a data logger with
' capacity limited only by the size of your hard disk.
' The program runs a Single Rate Test on Infutest Channel A and uses the
' Get Real-Time commands to retrieve test data from Infutest as it is
' measured. The Single Rate Test is run until the user hits the ESC key.
' LOGGER.BAS is a simple program which is ideal for saving the large
' amount of data produced during overnight tests.
' LOGGER.BAS begins with some input prompts allowing the user to enter
' the pump make/model, ECN and so on. More INPUT statements can be added
' here to input other info (Department, Location, etc.
' LOGGER.BAS creates a new file for your test data, or overwrites existing
' files. If you want the test data appended onto a file which already exists
' in the current working directory, use 'APPEND' instead of 'OUTPUT' as the
' file mode in the OPEN statement for device #2.
'
Main:
' Initialize COM1 for communication with Infutest.
OPEN "COM1:9600,N,8,1,CD0,CS0,DS0,OP0,RB2048,TB32" FOR RANDOM AS #1
' Clear the PC's screen and prompt user to input pump info
CLS
PRINT "HARD DISK DATA LOGGER"
PRINT
INPUT "Enter file name for storage of test data: ", filename$
PRINT
INPUT "Enter pump make and model number: ", Pump$
PRINT
INPUT "Enter pump equipment control no.: ", ECN$
PRINT
INPUT "Enter test rate (ml/hr): ", TestRate$
PRINT
PRINT "Flush Channel A, then start device pumping."
PRINT
PRINT "Press any key to proceed or <ESC> to abort now: ";
' Wait here for user to press a key
DO
  C$ = INKEY$
LOOP WHILE C$ = ""
IF C$ <> CHR$(27) THEN
  ' Open data file and print header info.
  ' Substitute 'APPEND' for 'OUTPUT' if you want the data appended
  ' to the end of an existing file.
  OPEN filename$ FOR OUTPUT AS #2
  PRINT #2, "          DATA LOG"
```

*Example #4: Hard Disk Data Logger (cont'd)*

```

PRINT #2, "          TEST DATA FILE: "; filename$
PRINT #2, "          TEST DATE/TIME: "; DATES$; " "; TIMES$
PRINT #2, "          PUMP MAKE/MODEL: "; Pump$
PRINT #2, "          CONTROL NUMBER: "; ECNS$
PRINT #2, "          TEST FLOW RATE: "; TestRate$; " ml/hr"
PRINT #2, "          SINGLE RATE TEST"
PRINT #2, ""
PRINT #2, "          Elapsed   Flow   Avg Flow   Volume   B.Pres"
PRINT #2, "          Time     (ml/h) (ml/h)    (ml)     (mmHg)"
' Clear PC screen and display data table headings
CLS
PRINT "Press <ESC> to stop test anytime."
PRINT
PRINT "Elapsed   Flow   Avg Flow   Volume   B.Pres"
PRINT " Time     (ml/h) (ml/h)    (ml)     (mmHg)"
VIEW PRINT 5 TO 25
PRINT #1, "RTA1"          ' Send START command to Infutest,
                        ' Chan A, SR Test
INPUT #1, IFTdata$      ' Get Infutest's "*" response
'----- DATA LOGGING LOOP -----
DO
' Delay 1 second
' Tzero! = TIMER
' DO WHILE TIMER - Tzero! < 1!: LOOP
SLEEP 1
' SLEEP 60 or 300 will pause for 60 or 300 seconds and reduce the
' number of data points saved, but not ALL instantaneous points
' will be collected
' Get real-time data from Infutest chan A
PRINT #1, "GRA"
INPUT #1, DataType$
' If data is not "x" (NO DATA READY), echo data
' to screen and save in file
IF DataType$ <> "x" THEN
    INPUT #1, Hr$, Mi n$, Sec$, Flow$, Avg$, Vol $, BPr$

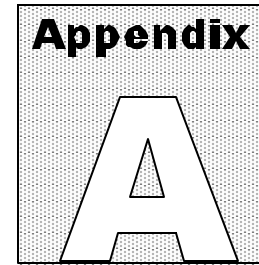
    PRINT Hr$; ": "; Mi n$; ": "; Sec$; " ";
    PRINT Flow$; " "; Avg$; " "; Vol $; " "; BPr$
    PRINT #2, "          "; Hr$; ": "; Mi n$; ": "; Sec$; " ";
    PRINT #2, Flow$; " "; Avg$; " "; Vol $; " "; BPr$
END IF
C$ = INKEY$          ' Loop until user hits ESCape key
LOOP UNTIL C$ = CHR$(27)
PRINT #1, "STA"      ' Send STOP command to Infutest
INPUT #1, IFTdata$  ' Get Infutest's "*" response
END IF
PRINT #2, "          END OF DATA"
' Close the data log file and turn off COM port
CLOSE
END

```

### **6.7.2 *medTester Programming***

The Infutest is fully compatible with the DNI Nevada medTester 5000B and the Fluke Biomedical medTester 5000C. Using the medTester, you may control the Infutest to automatically start and stop tests, and download test results into the medTester via the serial communications interface.

If you wish to interface the Infutest with a medTester, please contact Datrend Systems for further information.



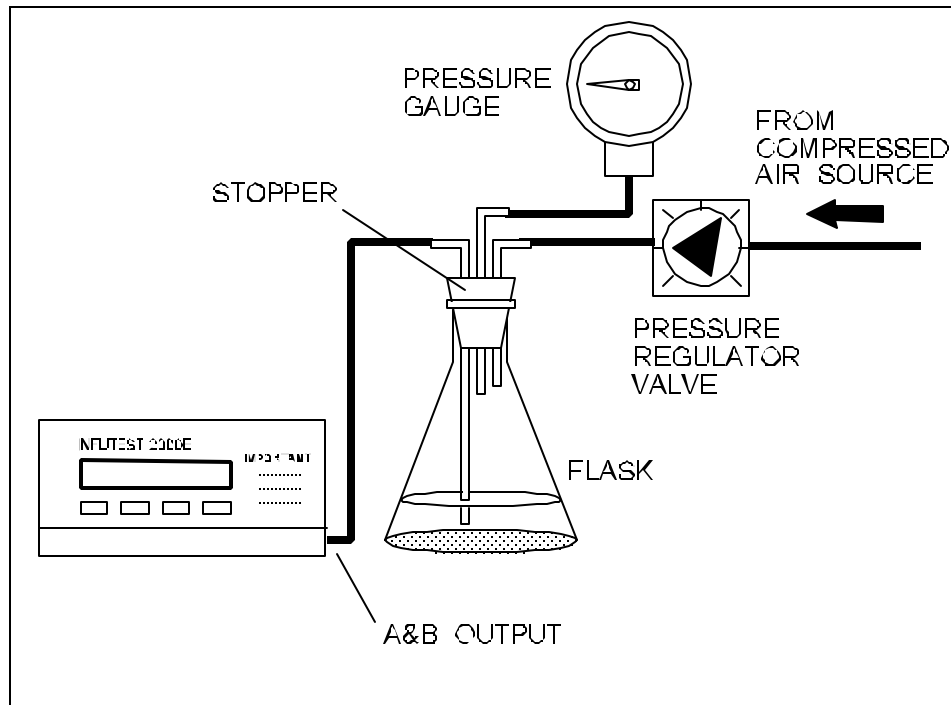
## APPENDIX A. BACK PRESSURE TESTING

A back pressure may be applied by the user to the infusion device under test (DUT) to oppose the flow from the device. Back pressures up to 300 mmHg may be applied during the Single Rate, Dual-Rate and PCA Pump Tests at the A&B Output of the Infutest. The Infutest will measure and display the back pressure during each of these tests.

This appendix describes apparatus and provides instructions for testing an infusion device with a pneumatically-applied back pressure. The test apparatus and method discussed are similar to those recommended by the **Association for the Advancement of Medical Instrumentation (AAMI)** in their proposed standard for infusion devices.

Connect the apparatus shown in *Figure 31* to the A&B Output of the Infutest as illustrated. The flask should have a large internal volume (1 to 2 litres) so that the fluid level within the flask does not change substantially during the test. The components and all seals should be capable of withstanding the maximum pressure applied to the system.





*Figure 31* - Apparatus for applying Back Pressure

Alternatively, a syringe bulb may be used to pressurize the flask instead of the compressed air source and regulator valve shown in *Figure 31*. This approach, although simple, has the disadvantage in that the back pressure is unregulated. If air leaks are present within the system, or if the water level within the flask changes substantially, the back pressure will be affected and the test results may be invalid.

To perform a Single Rate, Dual-Rate, or PCA Pump Test with an applied back pressure:

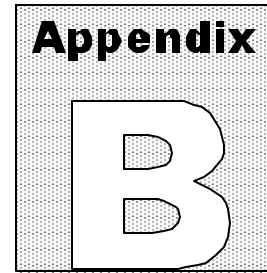
- a. **Power up the Infutest with NO PRESSURE applied to the A&B Output.** During its power-on self-test, the Infutest will auto-zero the internal pressure sensor.
- b. If a back pressure is detected at the time of power-up, the Infutest will produce an alarm via the SELF-TEST screen. Refer to Section 4.9, *Alarms*.

- c. After the START screen has been selected, the fluid system of *Figure 31* may be primed with water (see Section 3.2, *Priming*) and the flask pressurized up to a **maximum of 300 mmHg** before starting the test.

*Under no circumstances should a vacuum be applied to the A&B Output as this may damage the internal pressure sensor.*

- d. Water may be pumped out of the flask into the Infutest's A&B Output during pressurization of the apparatus. If this happens, reprime the Infutest once the apparatus has been pressurized so that the tubing connecting the A&B Output to the flask is completely filled with water.
- e. Prepare the DUT, then set up and start a Single Rate, Dual-Rate, or PCA Pump Test (see Sections 4.2, 4.3). The back pressure applied to the DUT will be measured, displayed on the TEST screen, and stored in the Data and Summary logs along with the measured flow and volume data.
- f. The back pressure should not be allowed to change for the duration of the test. IV tubing is compliant, and an increase in back pressure may cause a drop in measured flow and volume simply because the IV tubing is being stretched by the increased pressure in the system. Variations in device performance may therefore be more an effect of the tubing than of the device itself.





## APPENDIX B. OPERATIONAL OVERVIEW

### B.1 General Description

*Figure 32* is a block diagram showing the major assemblies of the Infutest. Test fluid flows from the Channel A and B inputs to the *Sensor Chassis* where the flow sensing system, comprising two flow sensors and a number of solenoid valves, is located. Channel pressure is measured via a transducer connected at each input via a tee. Fluid exiting the flow sensor on the Sensor Chassis is combined in a collection tank which drains out the A&B Output. Analog signals from the flow and pressure sensors are A-D converted and analyzed by the Test Controller (*TCO*), which also outputs valve control signals to the Sensor Chassis.

16-bit CPU of the TCO interacts with the sensors and valves, executing software algorithms (SynchroStart, flow pattern analysis, Single Rate Test, etc.) which perform the actual measurements. Calibration data for the flow and pressure sensors are stored in a 512-byte EEPROM located on the TCO. Calibration of the Infutest is completely software based - there are no manual adjustments or controls inside the unit.

Measurement data obtained by the TCO is serially transmitted to the *Display Unit* for display to the user. The Display Unit is based on an 8-bit CPU which operates the LCD, keypad, printer, serial and AUX interface ports. The Display Unit includes a real-time clock and a 32K RAM where measurement data from the TCO are stored (the "data log"). Contents of the 32K RAM are preserved by a 3 V lithium battery in the Display Unit when the Infutest is powered down.

After powering up the Infutest, the LCD will display *two software version numbers* following a successful self-test. The versions are displayed as "IFT / TCO", where "IFT" is the software version of the Display Unit (ie. 3.7/3.2).

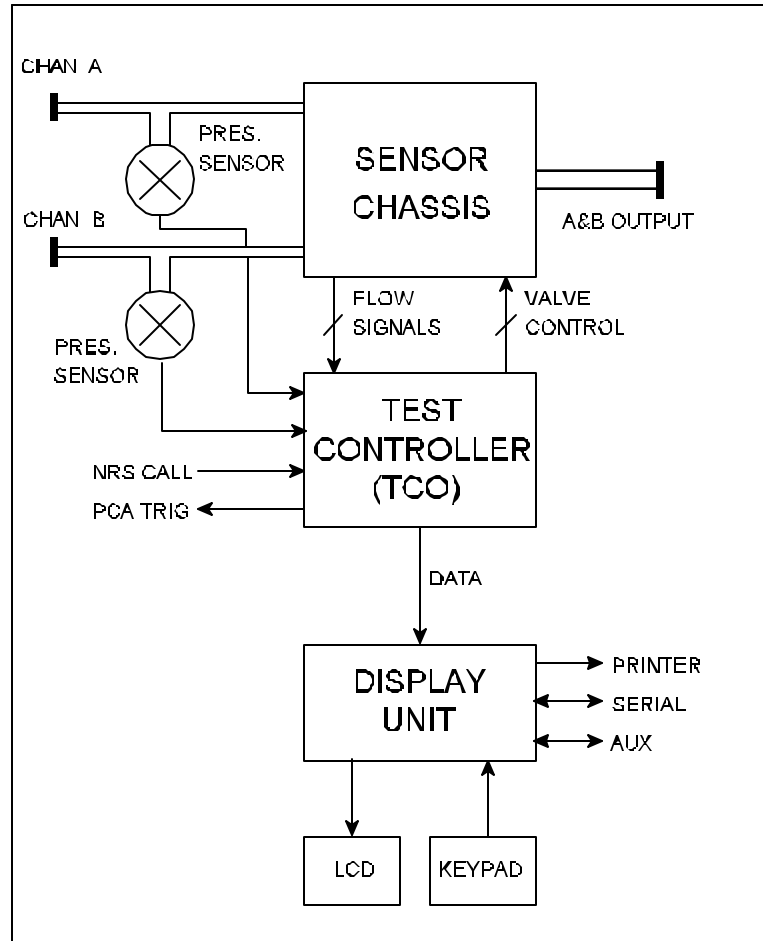
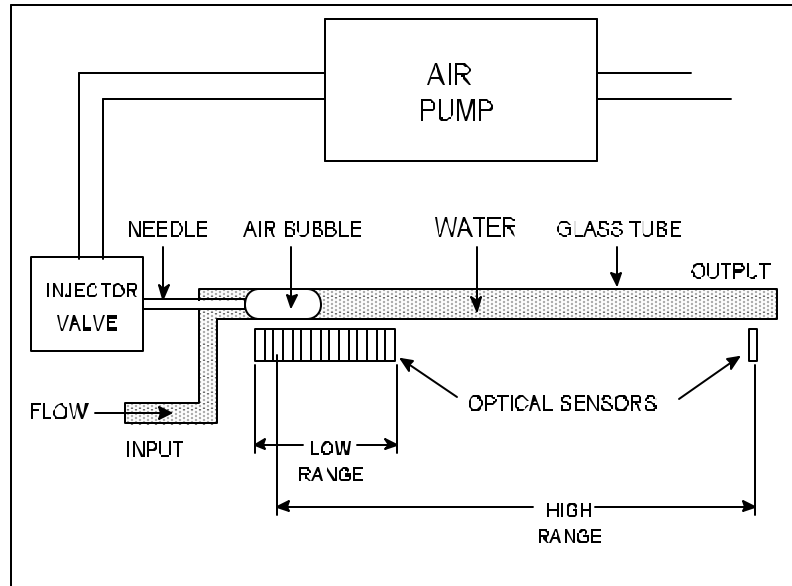


Figure 32 - Infutest Block Diagram

## B.2 Flow Measurement System

Figure 33 is a schematic diagram of the patented Infutest flow sensor. Pressure developed by an air pump is released through an injector valve, introducing an air bubble into the flowing fluid via a needle located at the sensor input. Fluid entering the flow sensor pushes the injected bubble through a glass capillary tube having an end-to-end volume of approximately 1.2 ml. Bubble position is tracked continuously using an array of 16 optical sensors located along the glass tube as shown in Figure 33.



*Figure 33 - Flow Sensor schematic diagram.*

The first 15 optosensors are used to measure flow over the low range (0.1 - 170 ml/hr). For high range flow (170 - 999 ml/hr), optosensor #3 and the output optosensor, #16, are used. Continuous flow measurement is performed by injecting a new bubble every time the preceding bubble passes the fifteenth (low range) or sixteenth (high range) optosensor.

Volume of the glass capillary tube between adjacent optosensors is calibrated at the factory to within  $\pm 0.0000052$  ml using a precision microsyringe dispensing system. These volume calibrations along with other flow sensor and pressure sensor calibrations are programmed into the TCO EEPROM.

Flow measurement is accomplished based on a transit time principle. As described, volume of the glass tube between optosensors is known precisely. Flow is derived by measuring the time required for the bubble to cross these calibrated volumes. Volume is derived by summing up the calibrated volumes incrementally as the bubble crosses them. Signals from the optosensors are continuously analyzed and dynamic corrections may be applied by the software algorithms depending on rate and the fluid delivery pattern of the device under test (*flow pattern analysis*).

*Figure 34* illustrates how each flow sensor is incorporated into the patented Infutest flow sensing system. After the test fluid passes through the flow sensors, the fluid is collected in a large tank inside the Infutest before draining out the A&B Output. Pneumatic feedback from the tank to the air pump ensures the injected bubble size

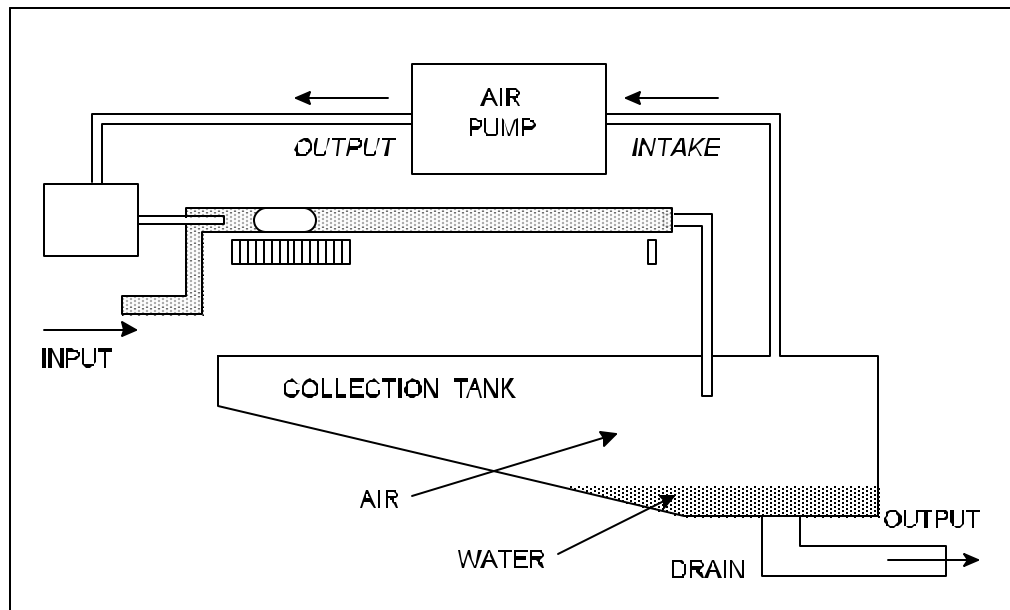
remains independent of pressures or moderate vacuums applied at the A&B Output.

As shown in *Figure 34*, the collection tank of the pneumatic feedback system is mostly filled with air. Because of this, fluid draining from the Output is poorly correlated with flow entering the input.

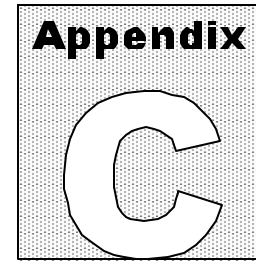
### **B.3 Pressure Measurement System**

*Figure 32* shows a pressure transducer located at each channel's input. During Single Rate, Dual-Rate and PCA Pump Tests, the transducer is used to measure pressure in the channel, which is displayed as Back Pressure.

During the Occlusion Pressure Test, a solenoid valve on the Sensor Chassis is activated which blocks fluid flow downstream of the pressure transducer. Pressure developed by the infusion device against the blockage is sensed by the transducer and displayed.



*Figure 34 - Flow Sensing System*



## APPENDIX C. CALIBRATION

### C.1 Annual Calibration

Calibration of the Infutest by an authorized service center is required on an *annual* basis to maintain the 2 year factory warranty. Refer to the Calibration Decal applied to the rear panel of the unit to determine calibration status of your Infutest.

The Infutest can only be **CALIBRATED** with specialized equipment and software found at Datrend authorized service facilities. This equipment allows proper adjustment of the internal electronics of the instrument.

Independent service centers *may* be able to perform a performance **VERIFICATION**; however, they will NOT be able to perform repairs or adjustments to your Infutest.

When calibration is due, contact Datrend Customer Service at 1-800-667-6557 about the authorized service facility nearest your location and to obtain an RMA number.

### C.2 Calibration Verification

#### C.2.1 Pressure Accuracy Verification - Field Test

Calibration of Infutest's pressure measurement system may be verified in the field by running an Occlusion Pressure Test with an external pressure gauge connected via a tee to the input. Validity of the pressure calibration verification will be dependant on the accuracy and traceability of the external gauge used.

#### C.2.2 Flow Accuracy Verification - Field Test

*Calibration of the flow measurement system CANNOT be verified in the field using infusion devices intended for medical applications. Such device lack the stability and repeatability required for checking calibration.*



*Calibration of the flow measurement system CANNOT be verified in the field using measuring devices connected to the A&B Output (see Appendix B).*

Calibration of the flow measuring system may be checked using a precision syringe pump of laboratory grade which has itself been calibrated using a gravimetric test protocol and apparatus similar to that defined in IEC 601-2-24 Part 2, or equivalently, ANSI Standard ID-26. We recommend Harvard Apparatus model 22 or model 44 with a precision-ground glass syringe or glass microsyringe having the minimum volume necessary for the verification, depending on the verification rates of interest (Harvard Apparatus USA, Holliston MASS, (800)-272-2775; ENGLAND Edenbridge, Kent, 44-1732-864001; [www.harvardapparatus.com](http://www.harvardapparatus.com)). For verification rates in the range 50 to 200 ml/hr, B-D Yale #2313 (precision 20 cc) is recommended.

If the test pump is a Harvard model 22 equipped with B-D Yale #2313, the test pump should be tested gravimetrically at 50 ml/hr and 200 ml/hr prior to each verification run on the Infutest. The pump should be allowed to dispense 1 ml at the selected rate before any test measurement is started. Use an analytical balance to measure the mass of distilled water effused from the test pump over 10 minutes at 50 ml/hr and over 4 minutes at 200 ml/hr. Calculate the average rate in ml/hr by dividing the mass by the specific gravity (0.9973 gm/ml at 24° C), and then by the test time. Compare this result to Infutest's Average Flow from a Single Rate Test of 10 minute (50 ml/hr) or 4 minute (200 ml/hr) duration. Three runs, consisting of a gravimetric measurement followed by the Infutest Single Rate Test, should be conducted to obtain repeatability of both the standard (gravimetric) and the Infutest.